



# SIPSMT10-12 SERIES

## 10 AMP

### POL CONVERTERS



### FEATURES

- \* Non-isolated POL Converter
- \* SIP / SMT Package
- \* Output Current 10AMP
- \* Input Voltage Range 9.0 – 14VDC
- \* 300KHz Switching Frequency
- \* High Efficiency to 95%
- \* Over Temperature Protection
- \* Continuous Short Circuit Protection
- \* Remote ON/OFF Control
- \* UL/C-UL60950 Certified

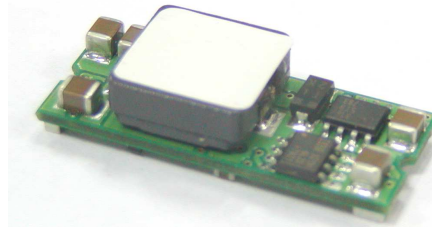
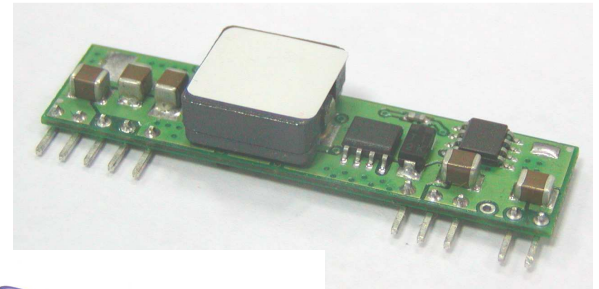

MODEL NUMBER	INPUT VOLTAGE	OUTPUT VOLTAGE	OUTPUT CURRENT	INPUT CURRENT		Efficiency (%)
				NO LOAD	FULL LOAD	
SIP10-12S10 SMT10-12S10	9.0 – 14VDC	1.0VDC	10A	50mA	992mA	84
SIP10-12S12 SMT10-12S12	9.0 – 14VDC	1.2VDC	10A	50mA	1163mA	86
SIP10-12S15 SMT10-12S15	9.0 – 14VDC	1.5VDC	10A	50mA	1404mA	89
SIP10-12S18 SMT10-12S18	9.0 – 14VDC	1.8VDC	10A	60mA	1666mA	90
SIP10-12S20 SMT10-12S20	9.0 – 14VDC	2.0VDC	10A	60mA	1832mA	91
SIP10-12S25 SMT10-12S25	9.0 – 14VDC	2.5VDC	10A	60mA	2264mA	92
SIP10-12S33 SMT10-12S33	9.0 – 14VDC	3.3VDC	10A	70mA	2956mA	93
SIP10-12S05 SMT10-12S05	9.0 – 14VDC	5.0VDC	10A	70mA	4385mA	95
SIP10-12S05A SMT10-12S05A	8.3 – 14VDC	0.75 -5VDC	10A	70mA	2956mA	93%@3.3V

NOTE: Nominal Input Voltage 12VDC

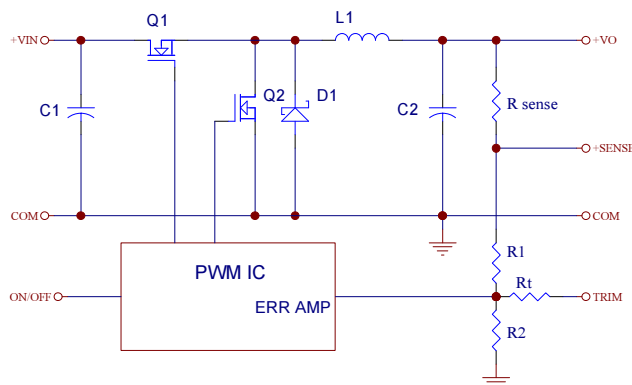

Vo,set (V)	Rtrim (KΩ)
0.75	Open
1.2	22.33
1.5	13.0
1.8	9.0
2.0	7.4
2.5	5.0
3.3	3.12
5.0	1.47

Table 1. Suffix "A" to the model number External Resistor Values for programming output voltage

Figure 1. Simplified Schematic

# SPECIFICATIONS

All Specifications Typical At Nominal Line, Full Load, and 25°C Unless Otherwise Noted

## INPUT SPECIFICATIONS:

Input Voltage Range.....	12V	9.0 – 14V
	12V	8.3 – 14V
Under Voltage Lock-out.....	Power up	8.0V typ.
	Power down	7.7V typ.
Input Filter Type .....	Capacitive	
Positive Remote on/off Control:		
Module ON .....	Open Circuit or =Vin	
Module OFF .....	<0.4Vdc	

## OUTPUT SPECIFICATIONS:

Voltage Accuracy .....	±1.5% max.
Transient Response: 25% Step Load Change .....	<200us
Ripple and Noise, 20MHz BW (note 3) .....	20mVrms max.
	50mVpk-pk max.
Temperature Coefficient .....	±0.03%/C max.
Short Circuit Protection .....	Continuous
Line Regulation (note 1) .....	±0.2% max.
Load Regulation (note 2) .....	±0.5% max.
Capacitive Load Low ESR .....	8000uF max.
External Trim Adj. Range .....	±10%
(SIP/SMT10-12S05) .....	+5%, -10%
(SIP/SMT10-12S05A) .....	0.75V – 5.0V
Start up time .....	7ms typ.

## GENERAL SPECIFICATIONS:

Efficiency .....	See Table
Isolation Voltage .....	Non-isolation
Switching Frequency .....	300KHz typ.
Over Temperature Protection .....	120°C typ.
Operating Ambient Temperature Range .....	-40°C to +85°C
Power Derating Curve .....	see Figure2, 3
Storage Temperature Range .....	-55°C to +125°C
MTBF .....	MIL-STD-217F, GB, 25°C, Full Load 0.98Mhrs typ.
Dimensions: SIP Package:.....	2.00x0.512x0.327inches(50.8x13.00x8.30 mm)
SMT Package:.....	1.30x0.530x0.366 inches (33.0x13.46x9.30 mm)
Structure .....	Non-potted With Open Frame Type
Weight .....	10g

## NOTE :

1. Measured From High Line to Low Line
2. Measured From Full Load to Zero Load
3. The output noise is measured with 10uf tantalum capacitor and 1uf ceramic capacitor across output.
4. The Input Terminal Recommend to Parallel With 100uF Capacitor ESR<100mΩ to Reduce The Input Ripple Voltage
5. Suffix "N" to the Model Number with Negative Logic Remote on/off  
 Model ON .....

## Dimensions:

### SIP Packages

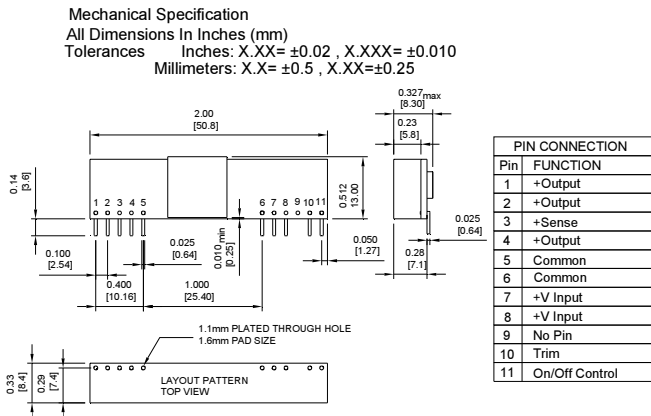

### SMT Packages

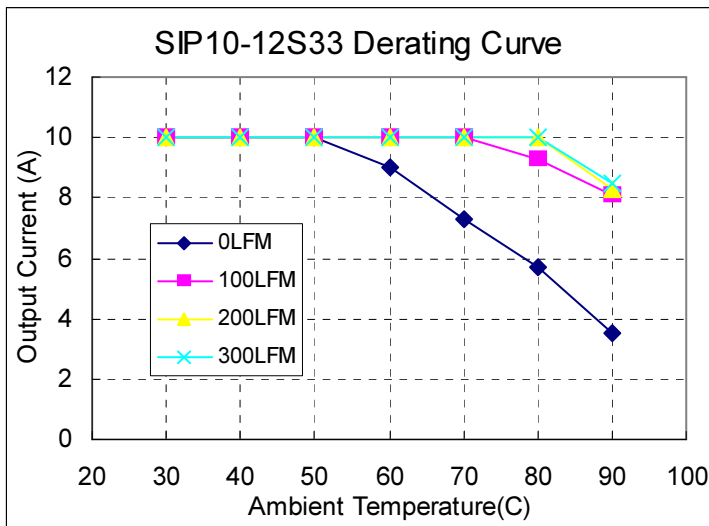
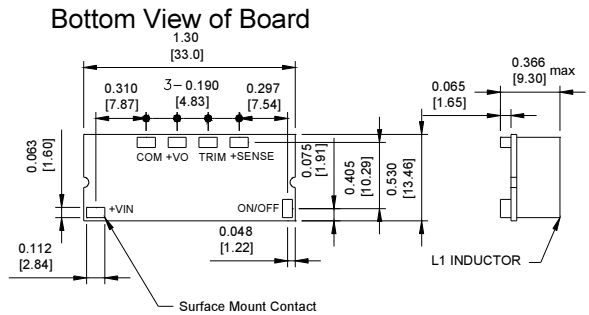

Figure2. Typical Power De-rating for 12V IN

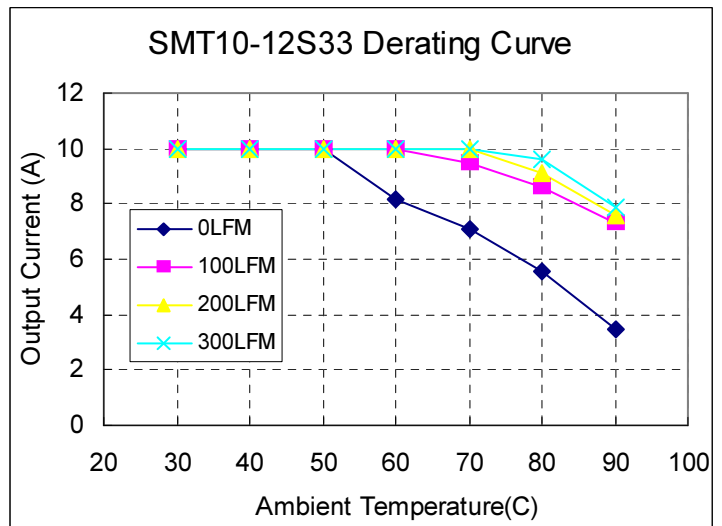

Figure3. Typical Power De-rating for 12V IN