

MOTOROLA
SEMICONDUCTOR
 TECHNICAL DATA

Designer's Data Sheet
Power Field Effect Transistor
P-Channel Enhancement-Mode
Silicon Gate

This TMOS Power FET is designed for medium voltage, high speed power switching applications such as switching regulators, converters, solenoid and relay drivers.



MTM20P10

TMOS POWER FET
20 AMPERES
 $R_{DS(on)} = 0.15 \text{ OHM}$
100 VOLTS

- Silicon Gate for Fast Switching Speeds — Switching Times Specified at 100°C
- Designer's Data — I_{DSS} , $V_{DS(on)}$, $V_{GS(th)}$ and SOA Specified at Elevated Temperature
- Rugged — SOA is Power Dissipation Limited
- Source-to-Drain Diode Characterized for Use With Inductive Loads

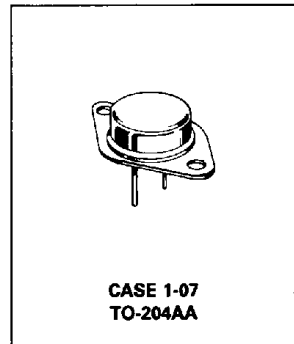
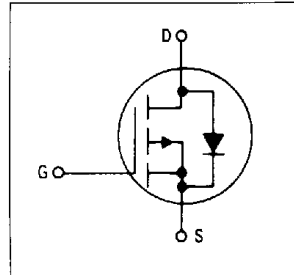

3

MAXIMUM RATINGS

| Rating | Symbol | Value | Unit |
|---|----------------|------------|---------------|
| Drain-Source Voltage | V_{DSS} | 100 | Vdc |
| Drain-Gate Voltage ($R_{GS} = 1 \text{ M}\Omega$) | V_{DGR} | 100 | Vdc |
| Gate-Source Voltage Continuous | V_{GS} | ± 20 | Vdc |
| Non-repetitive ($t_p \leq 50 \mu s$) | V_{GSM} | ± 40 | Vpk |
| Drain Current Continuous | I_D | 20 | Adc |
| Pulsed | I_{DM} | 80 | |
| Total Power Dissipation @ $T_C = 25^\circ C$ Derate above 25°C | P_D | 125 1 | Watts W/°C |
| Operating and Storage Temperature Range | T_J, T_{stg} | -65 to 150 | °C |

THERMAL CHARACTERISTICS

| | | | |
|--|-----------------|-----|------|
| Thermal Resistance Junction to Case | $R_{\theta JC}$ | 1 | °C/W |
| Junction to Ambient | $R_{\theta JA}$ | 30 | |
| Maximum Lead Temperature for Soldering Purposes, 1/8" from case for 5 seconds | T_L | 300 | °C |

Designer's Data for "Worst Case" Conditions — The Designer's Data Sheet permits the design of most circuits entirely from the information presented SOA Limit curves — representing boundaries on device characteristics — are given to facilitate "worst case" design

ELECTRICAL CHARACTERISTICS ($T_C = 25^\circ\text{C}$ unless otherwise noted)

| Characteristic | Symbol | Min | Max | Unit |
|----------------|--------|-----|-----|------|
|----------------|--------|-----|-----|------|

OFF CHARACTERISTICS

| | | | | |
|--|---------------|-----|-----------|-----------------|
| Drain-Source Breakdown Voltage ($V_{GS} = 0, I_D = 0.25 \text{ mA}$) | $V_{(BR)DSS}$ | 100 | — | Vdc |
| Zero Gate Voltage Drain Current ($V_{DS} = \text{Rated } V_{DSS}, V_{GS} = 0$) ($V_{DS} = \text{Rated } V_{DSS}, V_{GS} = 0, T_J = 125^\circ\text{C}$) | I_{DSS} | — | 10 100 | μAdc |
| Gate-Body Leakage Current, Forward ($V_{GSF} = 20 \text{ Vdc}, V_{DS} = 0$) | I_{GSSF} | — | 100 | nAdc |
| Gate-Body Leakage Current, Reverse ($V_{GSR} = 20 \text{ Vdc}, V_{DS} = 0$) | I_{GSSR} | — | 100 | nAdc |

ON CHARACTERISTICS*

| | | | | |
|--|--------------|----------|----------|------|
| Gate Threshold Voltage ($V_{DS} = V_{GS}, I_D = 1 \text{ mA}$) $T_J = 100^\circ\text{C}$ | $V_{GS(th)}$ | 2 1.5 | 4.5 4 | Vdc |
| Static Drain-Source On-Resistance ($V_{GS} = 10 \text{ Vdc}, I_D = 10 \text{ Adc}$) | $R_{DS(on)}$ | — | 0.15 | Ohm |
| Drain-Source On-Voltage ($V_{GS} = 10 \text{ V}$) ($I_D = 20 \text{ Adc}$) ($I_D = 10 \text{ Adc}, T_J = 100^\circ\text{C}$) | $V_{DS(on)}$ | — | 3.2 3 | Vdc |
| Forward Transconductance ($V_{DS} = 10 \text{ V}, I_D = 10 \text{ A}$) | g_{FS} | 5 | — | mhos |

DYNAMIC CHARACTERISTICS

| | | | | | |
|------------------------------|--|-----------|---|------|----|
| Input Capacitance | ($V_{DS} = 25 \text{ V}, V_{GS} = 0,$ $f = 1 \text{ MHz}$) See Figure 10 | C_{iss} | — | 2000 | pF |
| Output Capacitance | | C_{oss} | — | 950 | |
| Reverse Transfer Capacitance | | C_{rss} | — | 400 | |

SWITCHING CHARACTERISTICS* ($T_J = 100^\circ\text{C}$)

| | | | | | |
|---------------------|---|--------------|----------|-----|----|
| Turn-On Delay Time | ($V_{DD} = 25 \text{ V}, I_D = 0.5 \text{ Rated } I_D$ $R_{gen} = 50 \text{ ohms}$) See Figures 12 and 13 | $t_{d(on)}$ | — | 45 | ns |
| Rise Time | | t_r | — | 200 | |
| Turn-Off Delay Time | | $t_{d(off)}$ | — | 150 | |
| Fall Time | | t_f | — | 150 | |
| Total Gate Charge | ($V_{DS} = 0.8 \text{ Rated } V_{DSS},$ $I_D = \text{Rated } I_D, V_{GS} = 10 \text{ V}$) See Figure 11 | Q_g | 52 (Typ) | 75 | nC |
| Gate-Source Charge | | Q_{gs} | 22 (Typ) | — | |
| Gate-Drain Charge | | Q_{gd} | 30 (Typ) | — | |

SOURCE DRAIN DIODE CHARACTERISTICS*

| | | | | | |
|-----------------------|---|----------|-----------|---|-----|
| Forward On-Voltage | ($I_S = \text{Rated } I_D$ $V_{GS} = 0$) | V_{SD} | 2.8 (Typ) | 4 | Vdc |
| Forward Turn-On Time | | t_{on} | 100 (Typ) | — | ns |
| Reverse Recovery Time | | t_{rr} | 350 (Typ) | — | ns |

*Pulse Test: Pulse Width $\leq 300 \mu\text{s}$, Duty Cycle $\leq 2.0\%$.

TYPICAL ELECTRICAL CHARACTERISTICS

3

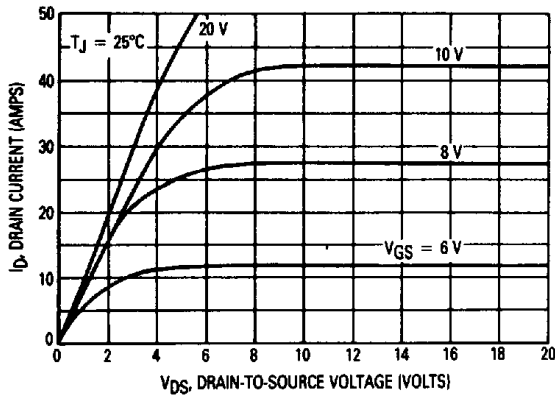

Figure 1. On-Region Characteristics

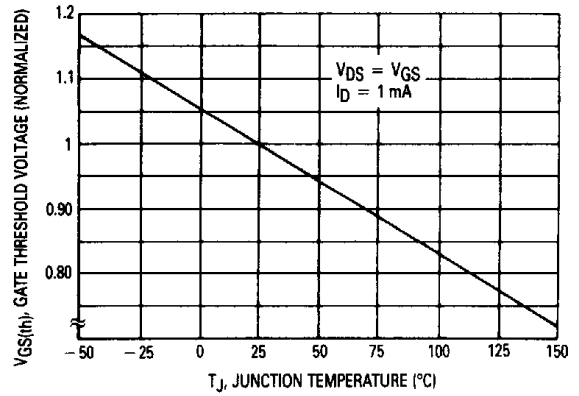

Figure 2. Gate-Threshold Voltage Variation With Temperature

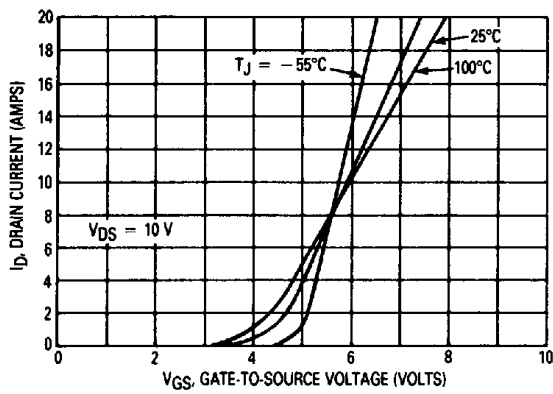

Figure 3. Transfer Characteristics

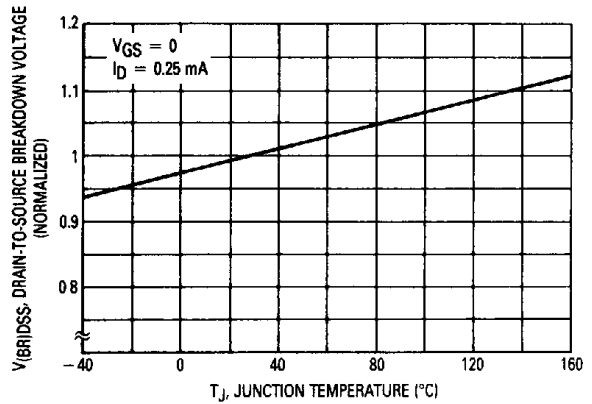

Figure 4. Breakdown Voltage Variation With Temperature

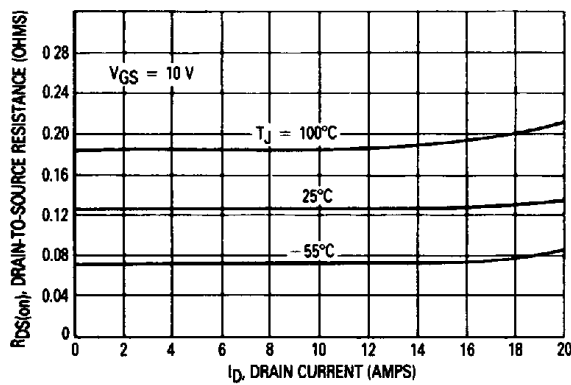

Figure 5. On-Resistance versus Drain Current

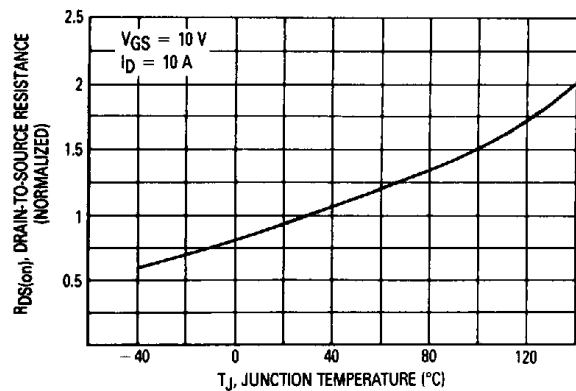

Figure 6. On-Resistance Variation With Temperature

SAFE OPERATING AREA INFORMATION

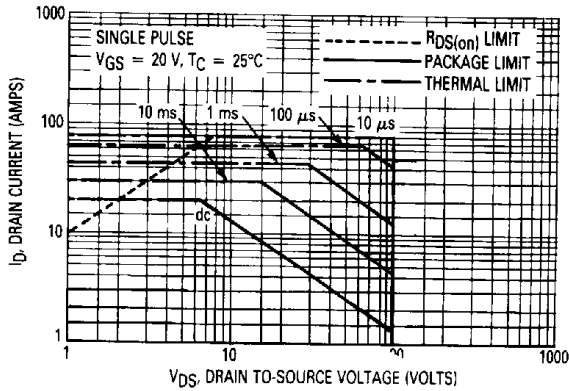

Figure 7. Maximum Rated Forward Biased Safe Operating Area

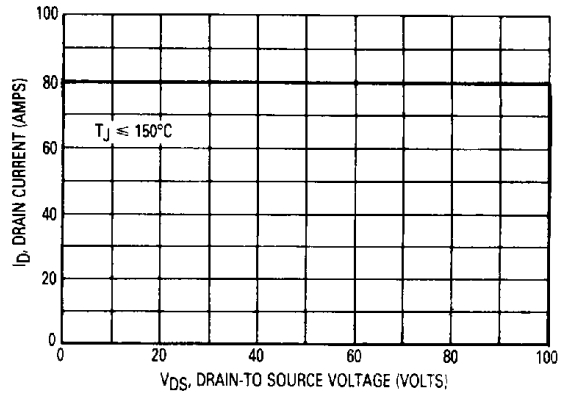

Figure 8. Maximum Rated Switching Safe Operating Area

FORWARD BIASED SAFE OPERATING AREA

The FBSOA curves define the maximum drain-to-source voltage and drain current that a device can safely handle when it is forward biased, or when it is on, or being turned on. Because these curves include the limitations of simultaneous high voltage and high current, up to the rating of the device, they are especially useful to designers of linear systems. The curves are based on a case temperature of 25°C and a maximum junction temperature of 150°C. Limitations for repetitive pulses at various case temperatures can be determined by using the thermal response curves. Motorola Application Note, AN569, "Transient Thermal Resistance-General Data and Its Use" provides detailed instructions.

SWITCHING SAFE OPERATING AREA

The switching safe operating area (SOA) of Figure 8 is the boundary that the load line may traverse without incurring damage to the MOSFET. The fundamental limits are the peak current, I_{DM} and the breakdown voltage, $V_{(BR)DSS}$. The switching SOA shown in Figure 8 is applicable for both turn-on and turn-off of the devices for switching times less than one microsecond.

The power averaged over a complete switching cycle must be less than:

$$\frac{T_{J(max)} - T_C}{R_{\theta JC}}$$

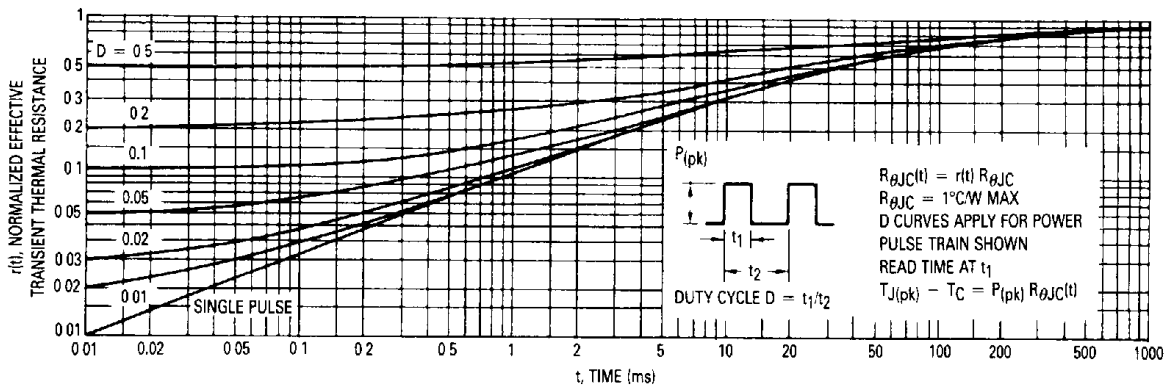

Figure 9. Thermal Response

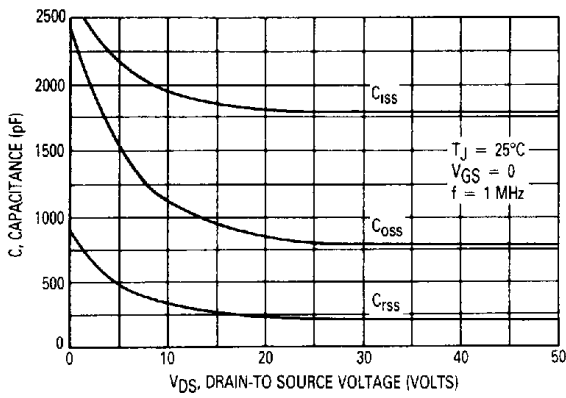

Figure 10. Capacitance Variation

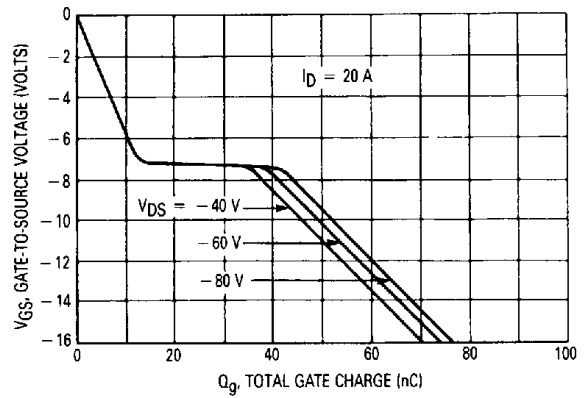

Figure 11. Gate Charge versus Gate-To-Source Voltage

RESISTIVE SWITCHING

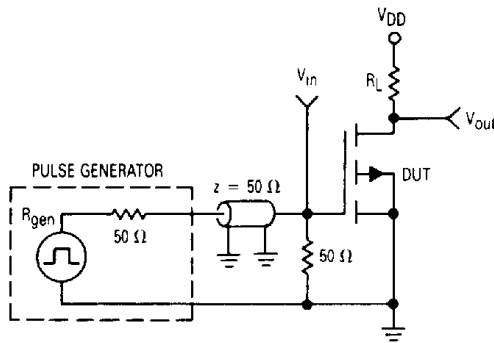

Figure 12. Switching Test Circuit

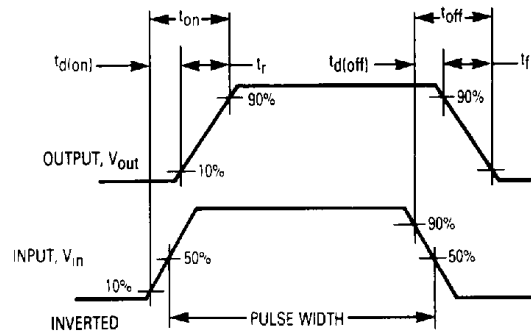

Figure 13. Switching Waveforms

This datasheet has been download from:

www.datasheetcatalog.com

Datasheets for electronics components.