

# Troubleshooting Your Oscilloscope:

Getting Down to Basics



# **Troubleshooting Your Oscilloscope:**

**Getting Down to Basics**

**TEKTRONIX, INC.**  
Test & Measurement Training

**Troubleshooting Your Oscilloscope:  
Getting Down to Basics**

068-0315-00

Copyright (C) 1989, Tektronix, Inc. All rights reserved. Printed in the U.S.A., Tektronix products are covered by U.S. and foreign patents, issued and pending. Information in this publication supersedes that in all previously published material. Specification and price change privileges reserved. TEKTRONIX, TEK, SCOPE-MOBILE and  are registered trademarks of Tektronix, Inc. TELEQUIPMENT is a registered trademark of Tektronix U.K. Limited.

## TABLE OF CONTENTS

	<u>PAGE</u>	
Chapter 1	TROUBLESHOOTING TECHNIQUES AND PROCEDURES	1
Chapter 2	TROUBLESHOOTING YOUR OSCILLOSCOPE	6
	Front Panel Diagnosis	7
	Isolating the Faulty Section	10
	The Basic Oscilloscope	10
	The Power Supply	13
	The Vertical Section	14
	The Horizontal Section	15
	Portable Oscilloscope Tips and Techniques	15
	Microprocessor Based Portable Oscilloscope	
	Tips and Techniques	17
	Lab Instrument Oscilloscope Tips and Techniques	18
Chapter 3	TROUBLESHOOTING THE POWER SUPPLY	21
	Checking Power Supply Regulation	22
	Resistance Measurements	23
	Transistor Supplies	24
	Common Power Supply Problems	25
Chapter 4	TROUBLESHOOTING THE HIGH-EFFICIENCY SUPPLY	27
	The High-Efficiency Power Supply	28
	Guidelines for Troubleshooting the	
	High-Efficiency Supply	30
	Typical High-Efficiency Supply Problems	34
Chapter 5	TROUBLESHOOTING THE CRT AND Z-AXIS SECTION	35
	The High Voltage Supply	36
	Typical High Voltage Problems	36
	CRT Conditions	37

Chapter 6	TROUBLESHOOTING THE VERTICAL SECTION	42
	Isolating Faulty Preamplifiers	44
	Isolating Faults in the Verticals of Laboratory Oscilloscopes	46
	Troubleshooting Tips for the Vertical Section	47
	Common Mode Operation	47
	Tracking Down a Noisy Circuit	49
Chapter 7	TROUBLESHOOTING THE HORIZONTAL SECTION	51
	Isolating the Horizontal Amplifier	53
	Lab Instruments Oscilloscope Tips and Techniques	54
	Typical Horizontal Problems	56
	Isolating Faults in the Timebase	57
	Timebase Sequence	58
	Tips for Troubleshooting Trigger Circuits	76
	Tunnel Diode Triggering	79
	Trigger Operation	81
	Tips for Troubleshooting the Sweep Circuits	83
	Typical Sweep Problems	84

## LIST OF ILLUSTRATIONS

	Page
Figure of Block Diagram	10
Basic Logical Steps for Troubleshooting an Oscilloscope	20
Regulation Indications of a Typical Transistor Power Supply	23
Power Supply Troubleshooting Flowchart	26
Troubleshooting Logic: CRT Not Unblanking	41
Common Mode Operation of a Push-Pull Amplifier	47
Common Mode Operation of IC Amplifier	48
Vertical IC Amplifier	48
Fault Isolation Flowchart: Vertical Section	50
Typical 'A' Sweep Sequence	59
465 'A' Sweep Sequence	71
465B 'A' Sweep Sequence	72
475A 'A' Locked Knobs Fast	73
475A 'A' Locked Knobs Slow	74
475A 'A' Unlocked Knobs or 'A' Intensified	75
Typical Block Diagrams for Solid-State Trigger Circuits	77
Tunnel Diode Triggering Voltages	79
Typical Curve Tracer Display for Tunnel Diodes	80
Trigger Level and Slope	81
Troubleshooting Flowchart: Sweep Circuit	82
Troubleshooting Flowchart: Spot off Screen on Left	87
Troubleshooting Flowchart: Trace off Screen on Right	88

CHAPTER 1

TROUBLESHOOTING TECHNIQUES AND PROCEDURES

## TROUBLESHOOTING TECHNIQUES AND PROCEDURES

To the technicians, good troubleshooting techniques are like money in the pocket. Though technicians may use different methods for troubleshooting, most of the better ones have a defined, repeatable pattern or technique that they use when troubleshooting. The best troubleshooters relate the visual symptoms and the front panel controls to the systems and circuitry within the faulty instrument. Armed with the understanding of these relationships, they perform the major portion of their troubleshooting from the front panel, using front and rear panel connectors for access to internal circuitry.

Furthermore, they do most of their major troubleshooting without removing the cover from the instrument and without using a lot of bulky test equipment. They use the test equipment only after they have determined which functional block within the unit is faulty.

Good troubleshooting procedures can cut your troubleshooting time in half. Through practice, these procedures will become "second nature", then you can focus more on the symptoms of the faulty instrument and less on the actual methods or procedures of troubleshooting. The following is an outline of the 8 Basic Steps for Troubleshooting:

Something to remember as you learn and use these procedures: Do not remove the cover from the instrument until you have isolated the fault to a section and/or block or until you have made all of the tests that you can from outside the instrument. The cover will prevent distractions and will reduce bad habits of haphazard troubleshooting as you follow the procedures.



## TROUBLESHOOTING TECHNIQUES AND PROCEDURES

1. SYMPTOM RECOGNITION - Note any irregularities in the display and in any other indicators on the instrument. "Milk" the front panel; notice how the front panel controls effect the display and indicators. Notice any interaction between the front panel controls themselves, and then between the controls and display. This step is much like a performance check. Remember, while performing this step, it is just as important to recognize and note proper operation as it is for faulty symptoms.
2. SYMPTOM ELABORATION - Again, "milk" the front panel. Develop the symptoms thoroughly. Use the front panel controls to find those hidden clues and symptoms that may be the key to understanding the fault. Use the connectors on the front and rear panels to gain more information, using signal injection and waveform testing. It sometimes helps to record the results of your testing to allow repeatability of the tests and to avoid confusion as you troubleshoot further.
3. SYMPTOM VERIFICATION - After you have worked out the details of the symptoms and indications of the fault, verify them. Repeat the operations and functions of the instrument that gave you faulty symptoms during the first two steps. This assures the repeatability of fault symptoms and verifies the proper operation that you noted in the previous steps. Performance of this step will decrease the possibility of some of those insidious "operator" errors that can be so costly to the technician while troubleshooting.
4. ISOLATE THE FAULTY SECTION/ASSEMBLY - If you have performed the first three steps correctly, you now have the information you need for this step. In essence, these steps are performed concurrently. By eliminating the sections of the instrument that are operating properly, you can derive the possible faulty sections. Use the front panel controls to further eliminate the "good" sections and to collect information that can help to isolate the fault. Use the front and rear panel connectors for signal injection and waveform testing. Remove the instrument cover and make a thorough visual inspection of any suspected areas. Make waveform and voltage measurements at points that would divide the suspected section into equal halves. Use other testing techniques, such as "common moding" and "plug-in swapping" to isolate the faulty section.

## TROUBLESHOOTING TECHNIQUES AND PROCEDURES

5. ISOLATE THE FAULTY BLOCK - Now that you have located the faulty section, continue to break it into smaller possible faulty blocks through a system of "successive approximation" techniques. Make your waveform and voltage measurements at the approximate midpoints of the suspected faulty section. If the measurements are correct, the fault is probably behind the measurement point. If the measurement is irregular or faulty, the fault is probably before the measurement point. Continue to test and measure until you have isolated the fault to a functional block. Remember, to continuously use the front panel display and indicator symptoms as you proceed.

In those instruments that have plug-in modules, troubleshoot by plug-in swapping. In instruments that have circuit boards (that are easily exchanged), isolate the fault by board and assembly swapping. Just remember, with either of these methods, always replace the boards and assemblies after you have located the fault.

6. ISOLATE THE FAULTY CIRCUIT - Make waveform and voltage measurements at the approximate midpoints of the functional blocks to further isolate the fault. Use special techniques, such as shorting the input to the delay line, to break the block up into its individual circuits. Study circuit schematics and calibration procedures closely for any hints which verify the suspected faulty circuits. Performance checks in the service manuals are often helpful at this point.
7. ISOLATE THE FAULTY COMPONENT - After you have isolated the suspected circuit, make a thorough visual inspection of the areas. If you should spot a burned or opened component, don't stop there. Burned and open components are often only symptoms of another, more real problem of the circuit.

Isolate the faulty component by making waveform, voltage, and resistance measurements in the circuit. Current measurements are also helpful in locating faulty components, especially in those cases where there are other burned components in the circuit. Troubleshoot the circuit by component substitution in those circuits where it can be done non-destructively. Use special techniques, such as "piggy-backing" and "swamping" for troubleshooting those circuits in which it is impractical to swap components.

## TROUBLESHOOTING TECHNIQUES AND PROCEDURES

8. REPAIR THE INSTRUMENT AND VERIFY PROPER OPERATION - Use accepted repair procedures to correct the fault. After the fault has been corrected, perform the instrument functions and operations which indicated the original fault to verify that the problem is corrected. If the instrument seems to be functioning properly, Performance Check it as directed in the Service Instruction Manual. Correct any additional faults or misadjustments that you find during the check.

CHAPTER 2  
TROUBLESHOOTING YOUR OSCILLOSCOPE

### Front-Panel Diagnosis

The oscilloscope is an excellent tool for providing clues to faults within itself. In addition to the CRT display, the calibrator signals and the front-panel indicators (trace position indicators, beam trace finder and pilot lights) often provide sufficient information to isolate the problem.

For effective troubleshooting, examine the simple possibilities before proceeding with extensive troubleshooting. The following list provides a logical sequence to follow while troubleshooting.

1. Check control settings
2. Check associated equipment
3. Make a thorough visual check of the instrument
4. Check instrument calibration
5. Isolate trouble to a block level
6. Check voltages and waveforms
7. Check individual components

Observing the effects of different multi-function switch positions can do much to identify a problem. For example, using the second channel of a dual-trace unit can check vertical circuitry up to the point where switching occurs. In the case of a delaying-sweep or dual-beam oscilloscope, a portion of the circuitry may be used to display information on the oscilloscope itself. Detecting a problem in all circuits may indicate a problem in the power supply.

Switching to the external horizontal input (X-Y mode) disconnects the sweep and is a means of determining whether a problem is associated with the horizontal amplifier or sweep generator. At the same time, it can indicate the condition of the unblanking circuitry.

Varying the trigger source switch between internal and external triggering checks the trigger pickoff circuitry. If the sweep will free run by adjusting the stability and trigger level control, additional circuitry may be checked. Comparing operation in different trigger modes can often localize a problem to a specific trigger stage.

## TROUBLESHOOTING YOUR OSCILLOSCOPE

Vertical preamplifier plug-in units are a quick way of checking performance to the vertical amplifier input. Once a problem is isolated to a specific plug-in unit, plug-in circuit boards (if used), may isolate the problem even further. Once a problem has been traced to a specific block, a close visual check may pinpoint the problem. Often times, the troubleshooting job can be shortened by spotting burned components or loose leads.

Another method of streamlining troubleshooting procedures is through the substitution method. This method can be used at many levels of troubleshooting. In troubleshooting instruments with plug-in modules, isolate the faulty sub-system by substituting known good plug-ins for those that are questionable. In those instruments that have plug-in boards, board substitution can help to quickly isolate a faulty board. Substituting the plug-in components offers a quick means of checking a suspected stage, however, there are some basic rules that you must remember and follow in using this method of troubleshooting:

1. Ensure that you use the proper components, by part number, when substituting.
2. Ensure that the power is removed when making the substitution, to prevent damage to the instrument and/or to the new component.
3. Be careful when removing and replacing components to avoid physical/mechanical damage to the components.
4. Keep the number of variables to a minimum; substitute only one component at a time. If a new component does not fix the fault, restore the original component in the circuit.
5. Though several components in a circuit may have the same part number, avoid inter-circuit component swaps. Failure to return components to their proper place within a circuit may require a complete calibration of the circuit. If components are replaced properly, the circuit may require only a performance check and spot calibration after the repair is completed.
6. Always return the components to their original places after the problem has been solved. As stated before, this will prevent the necessity of recalibrating the entire circuit after the repair.



## TROUBLESHOOTING YOUR OSCILLOSCOPE

After affecting repairs to a circuit, always check the replacement components to insure that the proper replacements have been used, this includes checking the suffix (last 2 numbers) of the part number. If the suffix numbers are not correct, the circuit may still operate but it may not calibrate properly. Even if it can be calibrated, another parameter of the device may have been selected for operation within the circuit, which may cause failure or improper operation in later use of the instrument.

# TROUBLESHOOTING YOUR OSCILLOSCOPE

## ISOLATING THE FAULTY SECTION

### The Basic Oscilloscope

The simplified block diagram below shows the major components of an oscilloscope. To be an effective troubleshooter, you must first understand the functional operation of the sections and blocks of the oscilloscope. You must also be able to relate the front panel controls to the display, and to the systems and circuitry within the instrument. Throughout the instrument there are internal signal paths and internally generated signals that can be accessed from the connectors on the front and rear panels. Your knowledge, and use, of these controls and ports can be powerful troubleshooting tools at your disposal.

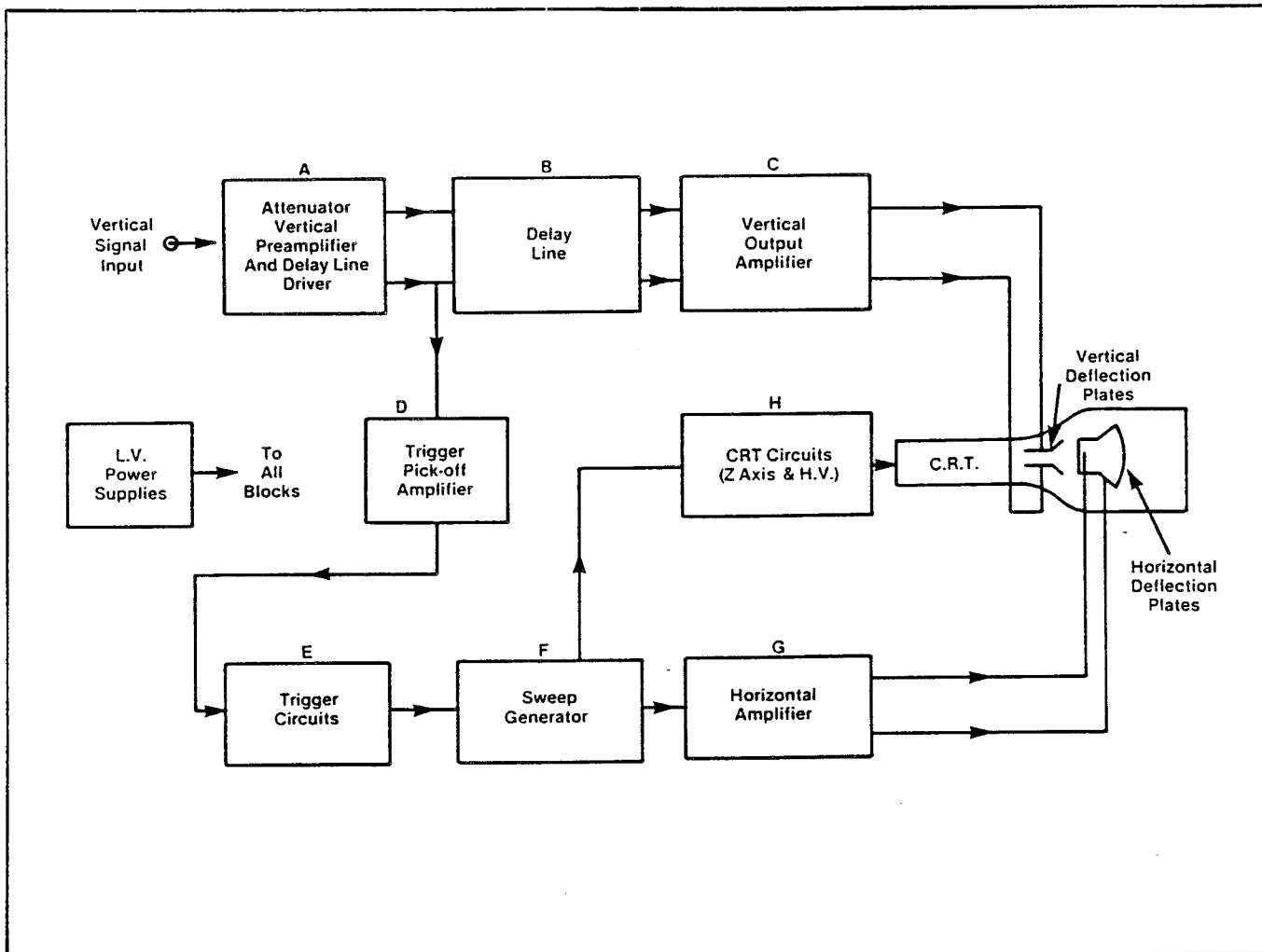

(Figure of Block Diagram)

When troubleshooting a new instrument, take some time to familiarize yourself with the block diagram. Spending a few minutes with the instrument's Instruction Manual can give valuable insight into the operation of an instrument and to the particular problem that may occur in the instrument.

The following description of the Basic Block Diagram is not intended to teach oscilloscope fundamentals. It is merely intended to orient you to the sections of the oscilloscope as represented and used in this book. By relating your knowledge of the oscilloscope's operation with the functions of its internal sections and blocks, you can become more proficient in isolating and repairing faults within most oscilloscopes. This is true because the basic operating and functional principals are the same for most oscilloscopes.

The ability to isolate a fault to one of these blocks comprises a major portion (the first 5 steps) of the troubleshooting procedure as described earlier in this book. Before troubleshooting, establish a starting point for which the display can be both predictable and repeatable. Set the front panel controls up as follows:

POWER CONTROLS

Line Voltage Selector	115V
POWER	ON

CRT CONTROLS

INTENSITY	Midrange (or as desired)
FOCUS	Best focused display
SCALE ILLUMINATION	As desired
B INTENSITY (if applicable)	Midrange (or as desired)

## TROUBLESHOOTING YOUR OSCILLOSCOPE

### VERTICAL CONTROLS (Both channels if applicable)

VOLTS/DIV	0.5V
VARIABLE	Calibrated detent
POSITION	Midrange
AC-GND-DC	DC
VERT MODE	CH 1
INVERT	Off
20MHz BW LIMIT	Off (Full bandwidth)

### TRIGGER CONTROLS

MODE	AUTO (if applicable)
SLOPE	+
COUPLING	DC
"A" SOURCE	INT
"B" SOURCE	STARTS AFTER DELAY

### SWEEP CONTROLS

HORIZONTAL DISPLAY	"A"
DELAY TIME POSITION	1.00
"A" TIME/DIV	1 mS
"B" TIME/DIV	.1 mS (100 uS)
VAR TIME/DIV	Calibrated detent
X10 MAG	Off
POSITION	Midrange
A TRIGGER HOLDOFF	NORM
TRACE SEPARATION	As desired

If you have not yet read the section on Troubleshooting Techniques and Procedures, do so before continuing in this book.

### The Power Supply

As you can see from the block diagram, the Power Supply provides the required operating potentials to all sections and blocks of the oscilloscope. Therefore, a fault in the Power Supply Section will usually affect several major blocks of the block diagram.

You should use the same basic troubleshooting procedures for isolating faults to the Power Supply section that you would use for isolating faults to any other section of the instrument. This starts with front panel troubleshooting: using the controls and indicators on the front panel, along with the connectors and switches on the front and rear panels.

If there are no CRT or "power on" indications at power up, check the POWER indicator. If the POWER indicator is not lit, check the Line Fuse and the position of the Line Selector Switch, if it is accessible from the outside of the instrument. Also check the other front panel indicators such as the VOLT/DIV and TIME/DIV skirt coding lamps, the TRIGGERED light, GRATICULE ILLUMINATION, and READY indicator. If none of the indicators are on and if there is no display, then the fault is probably in the L.V. Power Supply. At this point, if you suspect the Power Supply is faulty, refer to the chapter of this book on TROUBLESHOOTING THE POWER SUPPLY.

Even if there is a display or if there are front panel indicators operating on the instrument, the Power Supply may still be faulty. However, if the indicators are operating normally and if there is a display (sweep or dot), the fault is probably located in one of the other sections of the instrument. If you have front panel indicators and a display for troubleshooting, continue your fault isolation from the front panel.

## TROUBLESHOOTING YOUR OSCILLOSCOPE

### The Vertical Section

When no spot or sweep can be seen on the display, use the beam finder and the position control to see in which direction the spot or sweep is deflected. First, use the vertical position control to see whether the display can be centered. If the sweep will not center on the display, press the BEAMFINDER button and check for an on-screen display. If there is still no display on screen, the problem is likely to be in either the Power Supply Section, the Horizontal Section, or the CRT Section. If the trace is deflected to the top or bottom of the display when you actuate the Beam Finder, the fault is probably in the Vertical Section.

Most problems in the Vertical Section result from improper signal levels at the Vertical Input Connectors. Therefore, most catastrophic failures in the Vertical Section occur in the circuitry in the "front end" of the Verticals. By using the proper steps you can further isolate many of these problems to a sub-assembly or circuit, without removing the cover from the instrument. Try some of these before removing the cover from the faulty instrument. These steps will vary slightly according to the capabilities of the instrument.

Vertical systems containing plug-ins are convenient, since plug-in swapping and substitution may speed the logical troubleshooting process.

Now that you have isolated the fault to the Vertical Section, refer to the chapter on TROUBLESHOOTING THE VERTICAL SECTION.



### The Horizontal Section

Up to this point you have essentially eliminated two sections, the Power Supply and the Vertical Section, as the source of the fault within the instrument. Now you can further isolate the problem to one of the other sections of the oscilloscope (or confirm that it is one of the previous sections checked, such as the Power Supply).

Before continuing, ensure that the front panel is set up properly for a display. Set the timebase to "A", or Main Sweep, with the TIME/DIV switch in the 1 mS/DIV setting. Set the trigger section up for FREERUN (if available), INTERNAL TRIGGER, and AUTOMATIC, if the instrument has AUTO.

Rotate the INTENSITY control clockwise for desired brightness of the display. If the sweep appears and the display appears normal, do a Performance Check to insure proper operation of the instrument. A thorough Performance Check will sometimes reveal minor faults in an instrument that otherwise appears to operate normally.

If the display is only a dot that can be seen without pressing the Beam Finder, the fault is probably in the Horizontal Section. This condition indicates that a Sweep Gate (main Gate) has been generated but the Sweep Generator is locked up. Refer to the section on TROUBLESHOOTING THE HORIZONTAL SECTION.

#### Portable Oscilloscope Tips and Techniques

NOTE: These tips are applicable only to the Portable Oscilloscopes, such as the 400, 2200, and 2300 Series, that are not microprocessor controlled and do not have CRT readout.

NOTE: These techniques may not work on the new microprocessor based oscilloscopes, such as the 2400 Series, because the CPU controls the Display Sequencer and the Horizontal Section. The BEAM FINDER does not automatically unblank the CRT when pressed.

## TROUBLESHOOTING YOUR OSCILLOSCOPE

If you still do not have a display after the INTENSITY is turned up, set the INTENSITY control to the 12 o'clock position. Press the BEAM FINDER and observe the display. If a sweep appears on the display, it indicates a fault in the Unblanking Logic of the instrument. This particular problem may be located in either the Horizontal Section, the CRT and Z-Axis Section, or in the interface between the sections. (It could also be in the Vertical Section, but you have already eliminated that section if you followed the procedures.)

If you have only a DOT for a display when you press the BEAM FINDER, the fault is probably located in the Horizontal Section. Refer to the section of this book on TROUBLESHOOTING THE HORIZONTAL SECTION.

If you still have no display when you press BEAM FINDER, the fault is probably located in either the Power Supply or CRT/Z-Axis Section of the instrument. You can easily verify this from the rear panel of the instrument by using the following techniques:

**NOTE:** When using this technique, do not leave the injected voltage on the rear panel EXT Z-AXIS INPUT connector for more than a few seconds. Remove the voltage immediately because the intense beam on the CRT can damage the CRT.

Before continuing, turn the FOCUS control fully counter-clockwise. Inject -10 to -15 volts (DC) into the EXT Z INPUT connector on the rear panel. If you still have no display, refer to the sections of this book on Troubleshooting the Power Supply and on Troubleshooting the CRT and Z-Axis Section. If you get a very intensified dot on the CRT, the problem is probably in the Horizontal Section.

Don't forget about the output signal connectors, such as SWEEP GATE and SWEEP OUT, on the rear panel that can help you to verify your findings.

Microprocessor Based Portable Oscilloscopes Tips and Techniques

NOTE: This method can also be used on the other Portable Oscilloscopes, however, the results may not be as conclusive as those obtained by using the BEAM FINDER.

Notice that the EXT Z-AXIS input connector on the rear panel is now a TTL level input. This input can be used to blank the display by the application of +5 volts, however, it can no longer intensify or unblank the display. Therefore, you must use alternative methods of troubleshooting in these portable scopes.

Since the CPU controls the Display Section and the Horizontal Section of the microprocessor based portables, the BEAM FINDER does not automatically unblank the CRT when pressed. It merely limits the horizontal and vertical deflection to help locate the sweep/display so that it can be positioned on-screen. Therefore, it is very important that you have the TRIGGER MODE switch in the AUTO LVL or AUTO position to insure that you have a bright baseline (automatic) sweep. Also ensure that you have the sweep speed set to about 1 mS/DIV. If the sweep speed is set too slow, it appears as a dot when the BEAM FINDER is pressed and if it is offset to the top or bottom of the CRT, it may be lost in the compressed CRT Readout.

Rotate the INTENSITY control clockwise for the desired brightness of the display. If the sweep appears and the display appears normal, do a Performance Check to insure proper operation of the instrument. If the display is only a dot that can be seen without pressing the Beam Finder, the fault is probably in the Horizontal Section. This condition indicates that a Sweep Gate (Main Gate) has been generated but the Sweep Generator is locked up. Refer to the section on Troubleshooting the Horizontal Section.

If you still do not have a display after the INTENSITY is turned up, set the INTENSITY control to the 12 o'clock position. Set the READOUT INTENSITY to the 12 o'clock position. If you still do not have a sweep but the Readout is normal, the fault is probably in the Horizontal Section, Display Sequencer, or in the Z-Axis Section. Rotate the TIME/DIV control to the X-Y position. Center the CH 1 and CH 2 POSITION controls. If you get a bright spot on the CRT, the fault is probably in the Horizontal Section.

## TROUBLESHOOTING YOUR OSCILLOSCOPE

If you have no display on the CRT, press the BEAM FINDER. If the display is offset vertically, troubleshoot the Vertical Section. If the display is offset horizontally, troubleshoot the Horizontal Section. If you still have no display, troubleshoot the Power Supply and Z-Axis Sections.

### Lab Instrument Oscilloscope Tips and Techniques

NOTE: The following tips are valid for the Lab Oscilloscopes, such as 7000 Series, that use the plug-in configuration and have CRT Readout.

Before continuing, ensure that the front panel settings on both the mainframe and the timebase are set up properly for a display. Also be sure that any timebases installed are in the INDEPENDENT MODE.

Rotate the INTENSITY control clockwise for the desired display brightness. If the sweep appears and the display looks normal, do a Performance Check to insure proper operation of the instrument.

If the display is only a dot that can be seen without pressing the Beam Finder, the fault is probably in the Horizontal Section. This condition indicates that a Main Gate has been generated but the Sweep Generator in the timebase is locked up. Refer to the section on TROUBLESHOOTING THE HORIZONTAL SECTION.

If you still do not have a display after the INTENSITY is turned up, set the INTENSITY control to the 12 o'clock position. Set the READOUT INTENSITY control to the 12 o'clock position. If Readout appears on the CRT but you still have no sweep, the fault is located in either the Interface or in the Horizontal Section.

NOTE: If the Readout does not appear on the CRT, make sure that the READOUT MODE SWITCH, usually located internally, is set to the FREERUN position.

If there is still no display, press the BEAM FINDER button. If the display is offset on the CRT, troubleshoot the appropriate section. When you press the BEAM FINDER, if you have only a DOT for a display, the fault is probably located in the Horizontal Section. Refer to the section of this book on TROUBLESHOOTING THE HORIZONTAL SECTION.

If you still have no display when you press BEAM FINDER, the fault is probably located in either the Power Supply or CRT/Z-Axis Section of the instrument. You can easily verify this from the rear panel of the instrument by using the following steps:

NOTE: When using this technique, do not leave the injected voltage on the rear panel EXT Z-AXIS connector for more than a few seconds. Remove the voltage immediately because the intense beam can damage the CRT.

Before continuing, turn the FOCUS control fully counter-clockwise. Inject -10 to -15 volts (DC) into the EXT Z INPUT connector on the rear panel. If you still have no display, refer to the sections of this book on Troubleshooting the Power Supply and on Troubleshooting the CRT and Z-Axis Section. If you get a very intensified dot on the CRT, the problem is probably in the Horizontal Section.

Don't forget about the rear panel output signal connectors, such as SWEEP GATE and SWEEP OUT, that can help you to verify your findings. Once you have isolated the fault to the Horizontal Section, you can use a plug-in swapping technique to further isolate the problem. Some hints on these techniques are covered in the section on Troubleshooting the Horizontal.

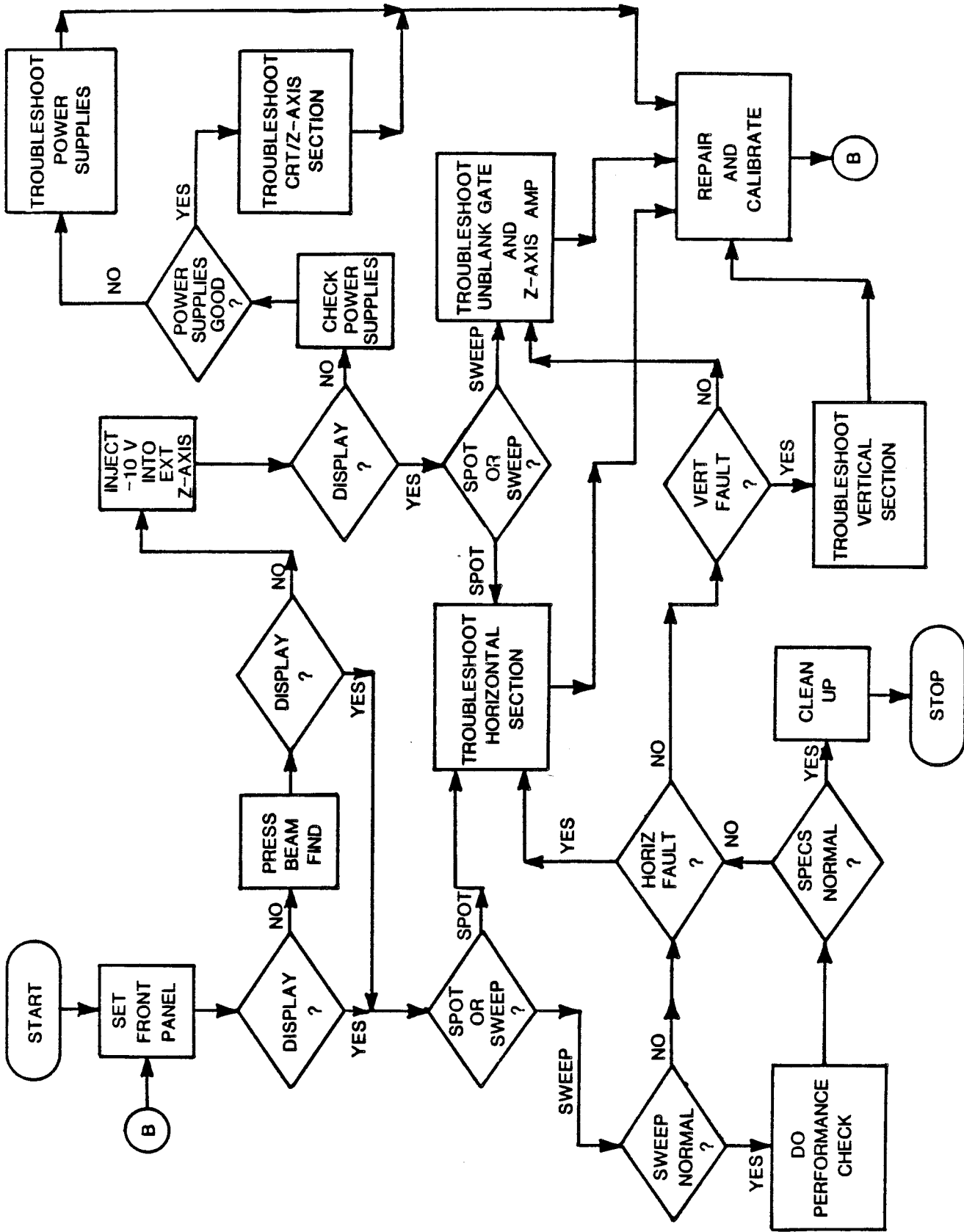

BASIC LOGICAL STEPS FOR TROUBLESHOOTING AN OSCILLOSCOPE



CHAPTER 3

TROUBLESHOOTING THE POWER SUPPLY

## TROUBLESHOOTING THE POWER SUPPLY

The power supply is the most fundamental block of an oscilloscope. The performance of the instrument is only as good as the condition of its power supply. The following information will assist in checking and obtaining the optimum performance from Tektronix power supplies.

Incorrect operation of all circuits usually indicates trouble in the power supply. Check first for correct voltage of the individual supplies. However, a defective component elsewhere in the instrument can appear as a power supply trouble, and may also affect the operation of other circuits. A short circuit in any regulated supply may cause the output level of all supplies in the instrument to drop to zero (until the short is removed). If the output level of all the supplies is incorrect, check that the Line Voltage Selector Assembly is set for the correct line voltage and regulating range.

Most Tektronix manuals list the tolerances of the power supplies. If a power supply voltage is within the listed tolerance, the supply can be assumed to be working correctly. If outside the tolerance, the supply may be misadjusted or operating incorrectly. When testing for shorts and overloads, remove the loads from the output filter. Check the resistance of each to isolate the load that's causing the short or overload. Next, look in the defective circuit for connections from the power supply directly to ground. Diodes and capacitors are a good place to start. Remember, ensure that you have removed instrument power before you make resistance checks.

### Checking Power Supply Regulation

Connect the oscilloscope under test to a variable auto-transformer. Turn off the sweep and calibrator, and monitor the individual supplies with a 1X probe, AC-coupled to the test oscilloscope. Begin with the reference supply since other supplies are related to this reference. Adjust the variable auto-transformer to the point where the supply goes completely out of regulation, noted by a large increase in ripple. Next, increase the line voltage to the point where the supply pulls into complete regulation, and note this voltage; this point is the low-line regulation voltage. Next, increase the line voltage to the point where the supply starts to go out of regulation. This point is the high-line regulation voltage. The figure at the top of the next page illustrates the various line conditions normally encountered.

Power Supply Noise

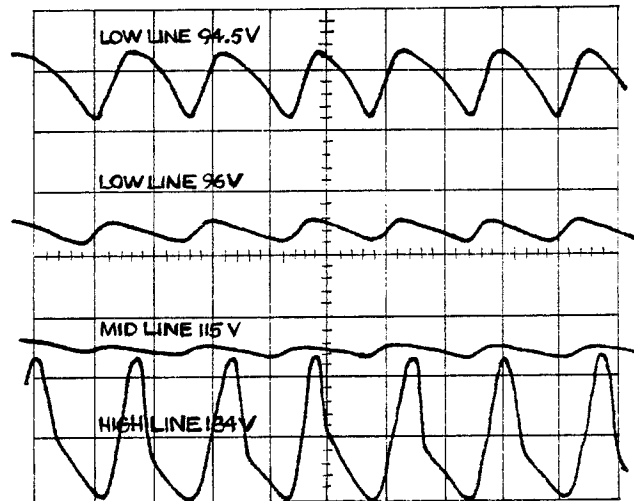

Regulation Indications of a Typical Transistor Power Supply

Resistance Measurements

Resistance measurements can be made on most supplies, since the resistance values are relatively low. Solid-state power supplies, because of their lower impedance qualities, have supply resistances that are typically lower than 50 ohms.

NOTE: When making resistance measurements, reversing the meter leads may produce a different reading due to diodes or other active devices in the load circuits.

Silicon diodes can usually be checked in the circuit and typically read about 2k ohms in one direction. When a power supply diode fails it will usually be either a dead short or open. If an in-circuit check of a diode leaves doubt as to its condition, lift one end of the diode to be sure of the reading. Most silicon supply diodes reach about 2k ohms or about 2M ohms, depending on direction of current flow.

NOTE: With a DOM range setting of 2 K ohms, a silicon diode will typically read about 600 ohms in one direction and infinite in the other.

## TROUBLESHOOTING THE POWER SUPPLY

### Transistor Supplies

Solid-state supplies are used in modern electronic equipment. The following points summarize the major characteristics of solid-state supplies:

1. Lower output impedance, resulting in lower output ripple -- usually on the order of 2 mV to 5mV.
2. Resistance of supplies is typically lower but checking is the same due to stacking of supplies.
3. Less problems with regulators because of less heat dissipation.
4. Supplies may be checked for shorts immediately after power is applied (no time delay relays).

If the regulators are not operating properly or if the supply operates intermittently (occasionally fails or blows fuses), use an auto-transformer to vary the line voltage and make checks around the supplies and regulators. To simulate the actual operating conditions of the circuitry, you can also vary the temperature of the circuits in operation. Use a hair dryer or heat gun to heat the Power Supply circuits to their operating temperatures. Cool the circuitry with an aerosol circuit coolant, such as Arctic Mist, to drop the circuit temperature back down to a start-up level. By alternately heating and cooling the circuitry in operation, you simulate the ambient conditions which the supplies normally encounter over a longer period of time (2 or 3 hours). Often this check will reveal heat sensitive devices early and may eliminate a "call-back" or the need to recalibrate the instrument under test.

Common Power Supply Problems

1. Fuse blows when power is applied -- shorted diode in bridge, shorted filter cap.
2. Fuse blows after delay -- overloaded output.
3. Excessive ripple -- divide by 10 for approximate solid-state value.
  - (A) 50 mV to 1.5 V -- comparator, speedup capacitor
  - (B) 1.5 V to 8 V -- output filter
  - (C) 8 V or more -- input filter
4. Off tolerance -- leaky speedup capacitor (lift one end, change both output voltage setting resistors).
5. Poor regulation:
  - at 117 V line -- weak comparator, defective bridge, bad filter component
  - at 105 V line -- weak regulator
6. Noisy output -- noisy comparator or regulator; noisy output voltage setting divider; noisy transistor or IC; poor connection; noisy diode; or noisy resistor.

# TROUBLESHOOTING THE POWER SUPPLY

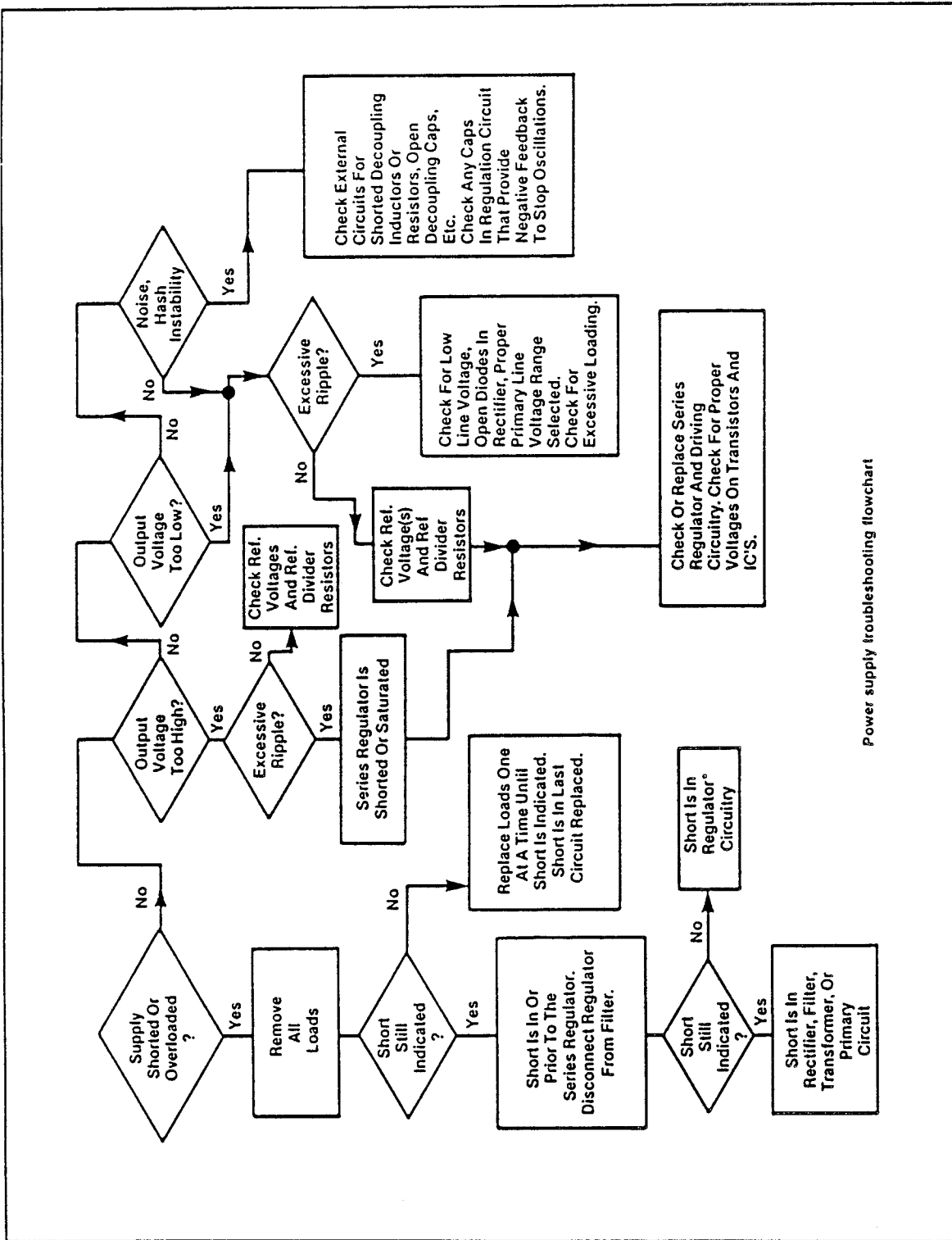

Power supply troubleshooting flowchart

## CHAPTER 4

### TROUBLESHOOTING THE HIGH-EFFICIENCY SUPPLY

## TROUBLESHOOTING THE HIGH-EFFICIENCY SUPPLY

Some instruments use a high-efficiency, low-voltage power supply in which the primary circuit compensates for changes in line voltage, line frequency and load demand. Compared to conventional regulated supplies high-efficiency power supplies present more of a challenge to the service technician.

### The High-Efficiency Power Supply

Here is a quick review of high-efficiency supplies. They are basically two stage AC to DC converters. The line voltage is rectified, then used to power an inverter that runs at approximately 25 kHz. The inverter drives the primary of the power transformer which provides the necessary secondary voltages. Regulation is usually accomplished by controlling the frequency at which the inverter runs, thereby controlling the energy applied to the primary. In some high-efficiency supplies, further regulation takes place in the secondary circuitry. Variations in line voltage are compensated by changing the duration of the "on" time of the current driver, while load variations are handled by changing the repetition rate of the "on" time.

Take a look at troubleshooting the supply. There are two items you will find useful: a power line isolation transformer and a current probe such as the TEKTRONIX P6021. The primary power supply circuit's common and guard box are elevated to line potential. The isolation transformer reduces the shock hazard and allows grounding the power supply's common for troubleshooting. The current probe is a convenient means of viewing the current waveforms associated with the current driver.



## TROUBLESHOOTING THE HIGH-EFFICIENCY SUPPLY

To troubleshoot a supply that won't start up, your ears may provide the first clue. If you listen closely you may hear a short "burst" (a signal of about 12 kHz) repeated several times per second. This indicates a probable short in one of the secondary supplies. What's happening is that when you turn the instrument on, the start circuit will try to start the inverter. The inverter will run at a frequency of approximately 12 kHz for one second, at which time the start circuit turns off. This happens when the inverter cannot produce adequate power to keep running because of the shorted secondary supply. After a fraction of a second, the start circuit tries to start the inverter again and the cycle repeats itself. The chirp (clicking noise) you hear is the transformer core responding to those short bursts of 12 kHz energy. The rate of the burst and the frequency of the audible chirp will vary according to the type of fault and the series of the instrument. When the supply is operating normally it runs at 25 kHz, well above the audible range.

When troubleshooting high-efficiency supplies, there are some basic rules to observe for your safety and for that of the equipment. Keep these in mind when working in and around the potentials present in the high-efficiency supplies, because a careless mistake in this circuit could be fatal. At the front of the inverter supply, there is 325 Vdc stored across the equivalent of about 1000 - 1500 uF of capacitance. Now consider how much energy must be dissipated when this voltage is discharged; it becomes something akin to a high-voltage, high-current welding machine. If discharged through a short, the energy from these capacitors would produce considerable heat and light (arc).

## TROUBLESHOOTING THE HIGH-EFFICIENCY SUPPLY

### Guidelines for Troubleshooting the High-Efficiency Supply

When working in the high-efficiency power supply, use the following guidelines to protect yourself and the equipment:

1. Do not attempt to troubleshoot or take any voltage or waveform measurements in and around the supply without using an isolation transformer and variac in series with the instrument under test.

It is necessary to isolate (float) the instrument under test because the high-efficiency power supply is not referenced to earth/chassis ground. The circuit "common" for this section of the instrument is taken from the negative (-) side of the input storage capacitors.

## TROUBLESHOOTING THE HIGH-EFFICIENCY SUPPLY

### CAUTION

Dangerous potentials may exist between equipment frames and connectors when an isolation transformer is used. Remember that the device connected to the isolation transformer is "floating" and does not have a solid ground reference. Your other test equipment will be operating at earth ground potentials on their chassis. If you should touch both pieces of equipment at the same time, you may be exposed to a dangerous potential difference.

Some of the more experienced technicians prefer to use a battery powered oscilloscope, instead of the isolation transformer, when troubleshooting the high-efficiency supply. This technique has several advantages. First, there is less danger of shock hazard, since the battery powered scope does not provide a current return path to any source to which the instrument under test is connected. The battery powered scope also provides higher portability for allowing the user to easily view the scope display while making those tricky connections in some of the more inaccessible locations. Because there are so few metal parts on the battery powered scopes, there is less chance of the user coming in contact with dangerous potentials between the instruments.

2. Apply test equipment ground to the negative (-) side of the Line Bridge Rectifier when troubleshooting the primary side of the inverter circuit. Notice that this point is also the negative side of the storage capacitor potentials. This point provides the circuit common for the rest of the circuitry.
3. Do not take any resistance measurements or make any repairs in the supply while the neon in the Line Rectifier circuit is blinking.

This neon is part of a Relaxation Oscillator that operates when the voltage on the storage capacitors is above 80 Vdc. When the neon is flashing, it is a warning that dangerous potentials exist in the circuit. Allow the charge on the storage capacitors to bleed down before proceeding.

## TROUBLESHOOTING THE HIGH-EFFICIENCY SUPPLY

After the neon has stopped flashing, make sure that the charge is completely bled off the capacitors before attempting repairs or resistance measurements.

4. Do not remove any of the protection circuitry, such as the Inverter Controller and the Inverter Regulator Transistors, and apply full power to the instrument. The high-efficiency supplies are capable of supplying enough current to burn the circuit boards, interface cables and circuit components. If you remove the protection circuits from the supply and apply full power, you may cause a catastrophic failure of the supply and to several other circuits in the instrument.
5. Use a Variac (variable transformer) to control the line voltage applied to an instrument when troubleshooting a faulty Power Supply.

When you have removed any of the protection or regulating components from a high-efficiency supply, limit the input line voltage to the instrument to 70V ac. Without this protection, full power applied to the line input can cause catastrophic failures. Seventy volts is sufficient to allow the inverter to work and allows you to observe and measure the operating characteristics of the circuitry.

With the protection circuitry installed and operational, you can gradually increase the line voltage to see at which point the protection and regulating circuitry begin to work. Sometimes you can troubleshoot in a faulty supply by increasing the supply voltage just enough to cause it to enter the "burst" mode or by leaving it at a level just below burst.

6. Do not remove the regulated supply loads when troubleshooting because this will prevent the Primary Inverter Circuit from operating properly. For isolation purposes you can remove a portion of the output load, such as the High Voltage drive output, from the secondary side of the inverter. However, you should load the power supply by installing at least 2 plug-ins in the instrument to allow the circuit to come up to normal operation.

## TROUBLESHOOTING THE HIGH-EFFICIENCY SUPPLY

Here are some quick checks that may help you isolate faults in a failed supply:

- Check for approximately 330V dc across the inverter switching transistors.
- Check for start pulses at the anode of the PUT (SCR) in the start-up circuit.
- Check for 32V across the inverter start-up transistor.
- Check to see if the over-voltage transistor is turned on.

## TROUBLESHOOTING THE HIGH-EFFICIENCY SUPPLY

### Typical High-Efficiency Supply Problems

If the supply won't come up, and it isn't evident what the problem is, the following troubleshooting hints may help.

Scope inoperative. No burst operation.

Solution: Check fuses. If they are blown and continue to blow when replaced, it indicates that an inverter is probably shorted.

Scope inoperative. Burst operation; hear ticking sound.

Solution: Check resistance of scope power supplies, if the values are given in the service manual.

Scope inoperative. Burst operation. Resistance normal.

Solution: Check for leaky or shorted capacitors on the rectifier board.

Burst operation. Semi-regulated voltage normal.

Solution: Possible CRT shorted.  
Shorted component on high-voltage board.

No inverter operation.

Solution: Check components on inverter board (use Curve Tracer).  
Primary transistors and capacitors.  
Check transistors and capacitors in the primary of the inverter.

Unstable inverter operation.

Solution: Check semi-regulated voltage on capacitor-rectifier board.  
Check for faulty components on inverter board.

CHAPTER 5

TROUBLESHOOTING THE CRT AND Z-AXIS SECTION

## TROUBLESHOOTING THE CRT AND Z-AXIS SECTION

### The High-Voltage Supply

The high-voltage supply is fundamental to oscilloscope/CRT performance. Cathode-ray tubes require DC operating voltages much higher than those provided by conventional power supplies. To eliminate large vacuum tubes, bulky and dangerous capacitors, and heavily insulated transformer windings, most Tektronix high-voltage power supplies use voltage multipliers to generate high voltages, with a considerable savings in cost and space.

By using a frequency of approximately 40 kHz to 60 kHz instead of 60 Hz, the required filter capacitor values are reduced by a factor of 1000. Thus, small and relatively inexpensive disc capacitors (0.02-0.03 microfarad) can be used instead of expensive 20 microfarad capacitors. A class C oscillator usually develops the 40-60 kHz voltage that supplies the primary winding of the high-voltage transformer.

Satisfactory regulation is achieved in most high-voltage supplies by controlling the amplitude of the high-frequency oscillator output. It is important to remember that CRT circuits are very low-current circuits, as a result they are susceptible to leakage paths.

### Typical High-Voltage Problems

High-voltage power supply problems are usually indicated by one of the following CRT symptoms:

1. No intensity on CRT display
2. Full intensity on CRT display
3. No control over intensity and/or focus of CRT display
4. Incorrect vertical and horizontal calibration

The control-grid supply is normally 40-50 V more negative than the cathode supply. If these two supplies decrease their bias for some reason, the high-voltage supply can draw sufficient current to drive it out of regulation. The intensity control varies the bias of the CRT.



## TROUBLESHOOTING THE CRT AND Z-AXIS SECTION

Most Tektronix cathode-ray tubes will cut off when the grid is approximately 65 V more negative than the cathode. If the CRT is weak, you can even get down below the cutoff point of the tube.

### CRT Conditions

Gassy CRT's may be identified by their "double-peaking" characteristic. When the CRT is cold, this fault normally produces two very pronounced spots where the CRT turns on. As the intensity control is advanced clockwise (CW), a dim trace appears and continues to decrease in intensity, then it increases somewhat toward the CW extreme. Once a tube begins to display this characteristic, a self-destructive process has begun and it is only a matter of time until the tube must be changed. Gassy CRT's also often exhibit poor focus and brightness characteristics, and a static charge phenomenon. Static charge problems are typically caused by dirt, so if this characteristic is noted, the CRT face and cover should be thoroughly cleaned.

A problem similar to static charge is sometimes caused by the CRT-gun support rods becoming charged. This rod charge may sometimes be eliminated by deflecting the electron beam completely off-screen horizontally, turning the intensity fully CW and varying the position control rapidly from the upper extreme to the lower extreme. After a few moments, the rod charge should be dissipated.

Burrs or dark spots on the CRT screen can sometimes be minimized or eliminated by "flooding" the screen with a display and then turning the intensity up for several minutes. This can be done by injecting a high frequency signal (i.e. 100 MHz from an SG-503) into the vertical input. Set the output of the signal generator for a 1V p-p signal, centered in the display, then reduce the vertical deflection of the oscilloscope to .1v/div. Set the oscilloscope TIME/DIV to 1ms/DIV. Turn the intensity fully clockwise (CW) and leave it for about 3 to 5 minutes.

\* \* \* CAUTION \* \* \*

THIS COULD CAUSE DEGRADATION IN THE CRT IF THE INTENSITY IS KEPT FULLY CW FOR A LONGER PERIOD THAN 5 MINUTES. CAREFULLY WATCH THE OSCILLOSCOPE WHEN PERFORMING THIS PROCEDURE.

## TROUBLESHOOTING THE CRT AND Z-AXIS SECTION

Most modern general-purpose oscilloscopes have a transistorized solid-state high voltage supply. Some of the more common troubleshooting symptoms are listed below.

1. Inability to turn off the intensity is often caused by a weak D.C. Restorer diode in the control-grid supply.

A control grid to cathode short in the CRT will exhibit similar symptoms. To check for this condition, remove the socket from the CRT and note if the CRT bias changes. If the bias changes, then the loading is caused by the CRT load. The CRT filament supply should also be checked to insure that the problem is not caused by leakage in the filament transformer. Internal CRT grid shorts may not show up with ohmmeter resistance checks.

2. No brightness with normal intensity control settings, but slight intensity as the control is moved further clockwise, may indicate a weak CRT or cathode supply. Similar symptoms will be present if a CRT is gassy or if unblanking is not received from the time-base generator. A gradual increase or decrease in intensity is a symptom of weak rectifier diodes in either the control grid or cathode supplies. NOTE: DC Restorer diodes should be replaced at the same time to prevent differential aging problems and to eliminate the possibility of a repeated failure due to stressed/weakened diodes.
3. Don't forget calibration adjustments. Check GRID BIAS (Intensity Range) adjustments and their associated circuitry.
4. Lack of high voltage is commonly caused by loading (one or more of the secondary supplies is causing the oscillator to not run). In most high-voltage supplies, this will cause the oscillator to free run at a frequency slightly higher than normal. If the oscillator does not free run, then the problem is probably due to loading of the transformer by one of the secondary loads. By lifting the anode of the rectifiers in the secondary supplies, these stages may be eliminated.

## TROUBLESHOOTING THE CRT AND Z-AXIS SECTION

(Only the most positive anode leads need be disconnected in the high-voltage anode supply.) Check the high-voltage caps in a similar fashion by lifting component leads. If the oscillator now oscillates, reconnect the supplies one at a time to find which one is causing the loading. For example, if this procedure led to a problem in the grid supply, then the next step would be to check for resistance measurements from the intensity control to ground. A good idea is to remove the CRT socket to see whether this has any effect on the circuit symptoms. Also, disconnect the CRT anode lead. It is possible for a short in the CRT or extremely gassy tube to load one of the other supplies, preventing proper oscillator action.

If you suspect a leaky or shorted component in the grid circuit or cathode circuit, you may try this alternative method for fault isolation. Remove power from the instrument before you proceed. Connect the high voltage output from a curve tracer (or some other variable supply) to the cathode/grid circuit of the oscilloscope -- ensure that you connect it to the H.V. side of the components. This will simulate the negative H.V. of the cathode Supply. Now check around the grid/cathode supplies for faulty components. This is sometimes a useful way to check capacitor breakdown, etc.

Typical resistance value in the grid circuit is 4-5 megohms to ground. This holds true almost anywhere you measure in the circuit. If the components check out properly, the problem is probably in the high-voltage transformer, possibly one of the windings has a leakage path to the core.

Problems in the high-voltage anode supply sometimes show up as insufficient high voltage. Check the output filter capacitors and the anode coupling capacitors. Weak high-voltage rectifiers will also indicate insufficient high voltage. A poor connection at the CRT anode connector can show up as jitter in the sweep or as poor regulation.

**NOTE:** All solder joints on high-voltage chassis should have smooth surfaces. Any protrusions may cause high-voltage arcing, particularly at high altitudes.

## TROUBLESHOOTING THE CRT AND Z-AXIS SECTION

Some of the more recent Tektronix oscilloscopes have a CRT bias control. This adjustment is sometimes used as a maximum intensity control to allow the user to protect his CRT. When the instrument is adjusted in this manner and the intensity is limited, dimness problems may occur at the faster sweep speeds. If there is a brightness problem with a cathode-ray tube, check to be sure that the CRT-grid bias is properly set.

Intensity modulation (blank spots or uneven trace intensity) is often caused by heater-to-cathode leakage in the oscillator, bad neons in the CRT-grid circuit, or leaky coupling capacitors in the unblanking circuitry. These symptoms are often seen when high-voltage tubular capacitors have been replaced with disc capacitors. The problem is present at any speed and the frequency is usually about 10 kHz or less, relative to the oscillator frequency. Intensity modulation and control problems can also be caused by faults in the DC Restorer (Grid) circuits.

# TROUBLESHOOTING THE CRT AND Z-AXIS SECTION

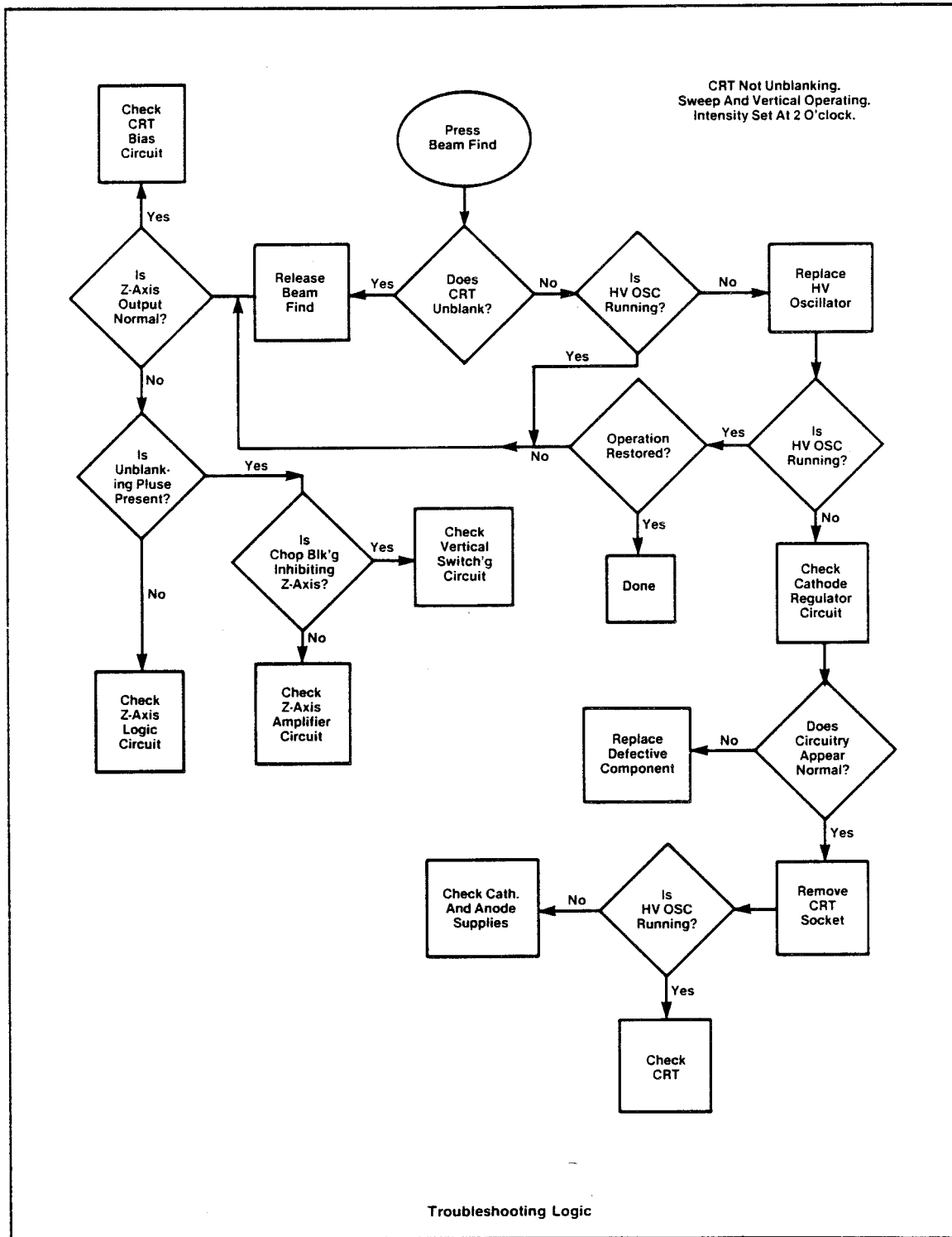

CHAPTER 6  
TROUBLESHOOTING THE VERTICAL SECTION

## TROUBLESHOOTING THE VERTICAL SECTION

The vertical amplifier develops a push-pull version of the input signal from the vertical preamplifier. These simultaneous positive and negative going amplified signal voltages are then applied to the upper and lower vertical deflection plates, deflecting the CRT spot as it traverses the screen. Thus, an accurately amplified reproduction of the original signal is displayed on the CRT. In addition, many oscilloscopes provide a vertical signal output which allows the amplified signal to drive other devices.

Once you have isolated a fault to the Vertical Section of the oscilloscope, you must use a more specialized technique to isolate the fault down to the block, circuit and component levels. You will now use more of the front panel vertical controls, and less of the other controls and indicators, through you will find that you can use the horizontal controls to help you troubleshoot the Vertical Section.

As you troubleshoot the Vertical Section, remember to "milk" the front panel for all the hints and clues available to help isolate the fault. In most cases you can isolate the faulty block level using only the front panel. In many cases you can even isolate the problem right down to the circuit. In any case, don't overlook the obvious."

Normally you would want to start troubleshooting in the middle of a faulty section to more quickly isolate the problem. However, you should examine the simple possibilities before proceeding with extensive troubleshooting. What is the most common type of failure in the Vertical Section? -- Front end failures. These failures usually occur when an operator connects a signal to the Vertical Input connection that exceeds the voltage rating of the instrument or when the instrument is grossly over-ranged; for example, 100V dc is applied when the VOLTS/DIV setting is at 10mV/DIV.

Since these front end problems are more common, you should first try to isolate them to, or away from, this area. In oscilloscopes with plug-in modules, you can do your initial isolation to the plug-in by swapping the suspect modules with modules that you know are operating properly. You can use the following procedures on those oscilloscopes and vertical plug-ins with dual channel inputs:

## TROUBLESHOOTING THE VERTICAL SECTION

### ISOLATING FAULTY PREAMPLIFIERS

1. Check Channel 1
  - A. Press and hold Beam Finder
  - B. Rotate the position control through its ranges and note any effect on the display
  - C. Check each position of the Volts/Division Switch
  - D. Check each position of the Coupling Switch

Any appreciable change in the display may indicate a fault in Channel 1 operation. Note these changes but do not remove the cover from the instrument or begin to troubleshoot the section yet. Continue to the next step.

2. Check Channel 2
  - A. Repeat the steps as indicated for Channel 1
  - B. Invert the display and check the display to see if the trace position is inverted on the CRT.

If the trace position inverts on the CRT when Invert is actuated, it indicates a fault in the input section of the Channel 2 Vertical Amplifier. For most Tektronix oscilloscopes, such a fault would typically occur within the first two active stages (Source Follower and Amplifier) of the Channel 2 Preamplifier. If the display does not invert, continue to the next step.

If the display is faulty in both Channel 1 and Channel 2, it normally indicates one of two things:

1. Both Channel 1 and Channel 2 are faulty.
2. Both Channel 1 and Channel 2 are good, and the fault is in one of the circuits after the Vertical Preamplifiers.

If one of the channels has a normal display and the other is faulty, then you'll know to troubleshoot the faulty channel preamplifier. If both are faulty, continue troubleshooting to further isolate the problem.



## TROUBLESHOOTING THE VERTICAL SECTION

If the fault cannot be isolated to one of the channel preamplifiers, isolate the problem to one of the other blocks in the Vertical Section by "successive approximation". Make tests at the approximate midpoint of the Vertical Section. If the section fails the test, the fault is probably located behind the test point. If the resulting display is good, the fault is usually located before the test point. By successively dividing the section into smaller sections and blocks, you isolate the fault into smaller and smaller sections of the instrument.

On those scopes equipped with TRIGGER VIEW, you have another troubleshooting tool. When TRIGGER VIEW is activated, the Trigger Signal from the Trigger Generator is normally injected into the Vertical Section's circuitry just before the Delay Line. This point is ideal since it breaks the Vertical Section up into approximate halves. If you press TRIGGER VIEW and the instrument has a normal display, the fault is probably located in the section before the Delay Line Driver.

Use the rear panel VERTICAL SIGNALS OUTPUT to help further isolate the fault. You can also use the Trigger controls in the Horizontal Section to help isolate the fault further. Set the TRIGGER MODE to NORM, TRIGGER COUPLING to DC, TRIGGER SOURCE to CH 1 (INTERNAL), and set the VERTICAL MODE to CH 1. Set the CH 1 VOLTS/DIV to 10mV/DIV and inject a 50mV signal into the CH 1 input. Rotate the TRIGGER LEVEL control and observe the TRIGGERED indicator. If the indicator lights, it indicates that the circuitry before the Trigger Pickoff circuit is OK.

After you have finished troubleshooting this far and you have isolated the fault down to one of the major functional blocks remove the cover and verify your conclusions. From this point on, your troubleshooting should be done using the "successive approximation" method while using as few tools and test instruments as possible.

## TROUBLESHOOTING THE VERTICAL SECTION

Where could you make a test that would divide the Vertical Section up into approximate halves? — If you said the Delay Line, you are correct. If you didn't, go back and look at the block diagram. Use a shorting strap (or screwdriver) to short the ends of the Delay Line together. If the display returns to about the center of the CRT, the fault is before the Delay Line. If the display is still off-screen, the problem is in the Vertical Output Amplifier, the CRT, or in the connections between them. In either case, before or after the Delay Line, use the general troubleshooting techniques presented in the back of this section to further isolate the problem.

## ISOLATING FAULTS IN THE VERTICALS OF LABORATORY OSCILLOSCOPES

The Vertical Section of Laboratory Oscilloscopes is made easier because of the modular nature of the plug-ins. You can divide and test the vertical section easily by simply swapping the plug-in. If the fault is removed when the plug-in is swapped, use the general troubleshooting tips in the back of this section to further isolate the problem.

If the fault is not affected by changing the plug-in, divide the remaining portion of the vertical section into half by using the CRT Readout. Turn the READOUT INTENSITY up to about the 12 o'clock position. If the Readout is on the display in approximately the correct position, but the sweep is deflected offscreen (use the BEAM FINDER to check), the fault is located in the circuitry before the Vertical Output Board. This can be verified by shorting the output ends of the Delay Line together where it connects into the Vertical Output Board. If the display is approximately centered on the CRT when the Delay line is shorted, the fault is in the Vertical Interface Board, the Delay Line, or in the connections somewhere between the output of the plug-in and the output of the Delay Line.

If the fault is not removed by shorting the Delay Line, the fault is either in the Vertical Output Board, the CRT, or in the connections to the CRT. Press the BEAM FINDER and observe the display. If the display can be seen on the CRT, the fault is probably on the Vertical Output Board.

## TROUBLESHOOTING THE VERTICAL SECTION

After you have isolated the fault to the board or block, use the general troubleshooting tips that follow to further isolate the problem.

### Troubleshooting Tips for the Vertical Section

Remember, as you continue to troubleshoot, you should continue to milk the front and rear panels for clues that may lead you to the source of the problem. You should also continue to use the "successive approximation" method of fault isolation.

#### Common Mode Operation

A simple clip lead can be invaluable for troubleshooting faults in which the beam is deflected off-screen. This technique is sometimes called "common moding" the stages.

In a transistorized circuit, this is accomplished by connecting a clip lead between the bases of the transistor pair in a Push-Pull Amplifier (it also works on Paraphase Amplifiers) as illustrated in Figure 1. If the trace deflects to about the center of the CRT, the fault is located before the stage that is shorted out. If the beam is still deflected off-screen, the fault is located after the connecting points.

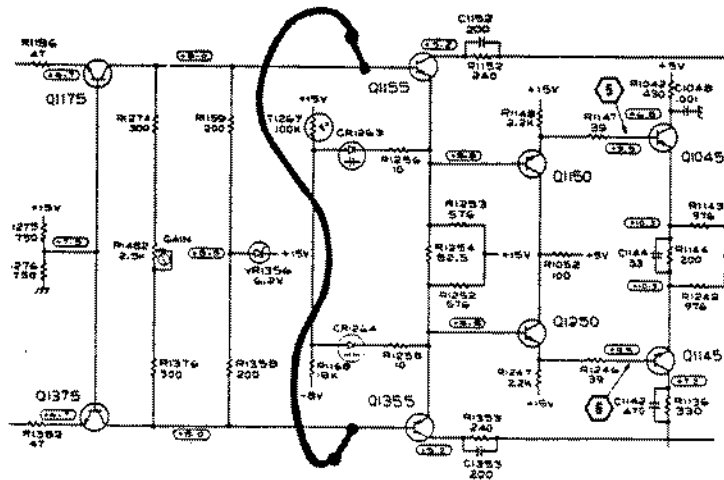

FIGURE 1

Common Mode Operation of a Push-Pull Amplifier

## TROUBLESHOOTING THE VERTICAL SECTION

This technique can also be used in those instruments that use Integrated Circuit Amplifiers. Simply use a clip lead to short the signal input pins of the amplifier stage, together as illustrated in Figure 2.

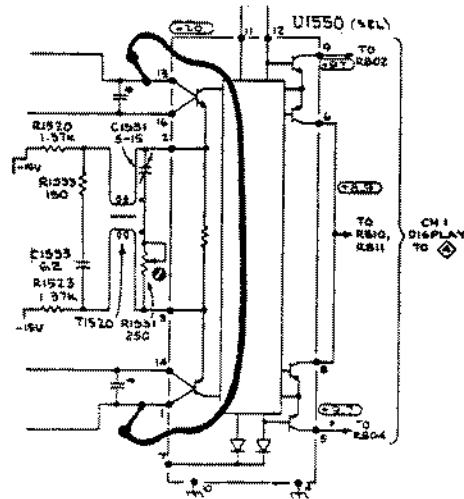

FIGURE 2  
Common Mode Operation of an IC Amplifier

Notice that this is an ideal technique for some instruments because of the configuration of the IC's used in the Vertical Amplifier circuitry. The example in Figure 2 is a Tek-made Vertical Amplifier, part number 155-0078-XX. This IC is used in the Vertical Section of many Tek oscilloscopes, such as the 465B, 475, and 475A, and also in Vertical Amplifiers such as the 7A26. These IC's can be shorted without using a shorting strap. Carefully short pins 1 and 6 together with the tip of a small "tweezer". Notice in Figure 3 that these pins are adjacent to each other on the IC and that they are marked by a "dot" (pin 1 indicator) on the body of the IC.

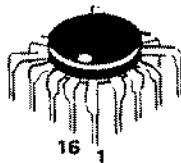

FIGURE 3: Vertical IC Amplifier

### Tracking Down a Noisy Circuit

You can also use the "successive approximation" method for tracking down noisy circuits and components. When tracking down the source of noise, you may use either the shorting strap as described in the previous tips or you may elect to observe the output of the selected amplifier stages with an oscilloscope. When using the shorting strap, short the input to a stage and observe the display. If the noise disappears, the noise is being generated in one of the circuits before the shorted input. If the noise continues, the fault is in the circuitry somewhere after the short. Whether you use the shorting strap or an oscilloscope to isolate the noise, simply divide the faulty section into smaller and smaller pieces until you have isolated the fault down to one or two stages of circuitry.

After you have the source of the noise isolated to a couple of suspect circuits, you will need an oscilloscope for further troubleshooting. Set the VOLTS/DIV on the test oscilloscope to 5mV/DIV (or less) and connect the test probe to the output of the suspect amplifier stage. Lightly tap the suspected components in the circuit with a "spudger" (a non-metallic wand) and observe the displays on the oscilloscopes. If you notice an appreciable increase in noise when a particular component is tapped, check the component carefully (or substitute) and check those components that are connected to the suspect component. A neat gun and a coolant spray may also help to isolate the fault to an individual component.

If the noise appears to be consistent in amplitude and frequency, it is probably a result of oscillations in the circuitry on the board. Because of the feedback nature of this kind of problem, it is harder to isolate the source of the noise -- it may be the result of interaction between several circuits or components. You may be able to solve this problem by re-orienting the lead dress of cables, connectors and components within the circuitry. When repositioning components, be careful or you may stress the leads -- this can cause fractures at either the component end or board end of the component lead. Do not adjust or reposition transistors that are soldered onto the board. Since transistors are three lead components, they form a triangular connection to the board. Any stress against the orientation of the transistor may cause damage to the board or to the transistor.

## TROUBLESHOOTING THE VERTICAL SECTION

If you have trouble locating the source of the oscillations, use a "snooping loop" to help. Form a 1 inch loop in the middle of an "easy clip" connector. Hold the loop so that it is parallel with the plane of the circuit board. Slowly pass the loop closely over the top of the suspect circuitry and closely observe the oscillations on the display. If you notice an appreciable increase or decrease in the amplitude or frequency of the oscillations as you pass the loop over a particular circuit or area of the board, troubleshoot the circuitry around that area.

CHAPTER 7

TROUBLESHOOTING THE HORIZONTAL SECTION

## TROUBLESHOOTING THE HORIZONTAL SECTION

We will assume, at this point, that you have followed the procedures in the section of this book on ISOLATING THE FAULTY SECTION. We will also assume that you have isolated the fault to the Horizontal Section using the procedure under the sub-title of HORIZONTAL. If you have not read that section of the book and have not performed the procedures for isolating to the Horizontal Section, go back and do so at this time. Refer to the Table of Contents to locate this section.

The Horizontal Section of the oscilloscope is responsible for the generation of the gate logic for unblanking the CRT, and for the generation and processing of the sweep signal used to drive the horizontal section of the CRT. The Horizontal Section consists of the Trigger Generator, the Sweep Generator, and the Horizontal Amplifier.

Once you have isolated a fault to the Horizontal Section, you can begin to isolate it to the smaller sections and blocks. The Front Panel is still the best tool you can use for troubleshooting -- milk the Front Panel controls for all symptoms and indications. Don't forget that you also have the signal outputs on the rear panel to help you troubleshoot the instrument. For effective troubleshooting, examine the simple possibilities before proceeding with extensive troubleshooting.

The first thing to do when isolating a fault in the Horizontal Section is to break the section down into two sub-sections:

Timebase	Consists of the Trigger Pickoff Circuit, the Trigger Generator, and the Sweep Generator. This circuit is responsible for processing an input trigger signal (internal or external), generating the gate logic for unblanking and sweep, and generating a precise linear ramp for driving the Horizontal Amplifier.
Horizontal Amplifier	Processes and amplifies the sweep voltage from the Timebase and provides the drive signal required for the horizontal deflection of the beam across the CRT.



## TROUBLESHOOTING THE HORIZONTAL SECTION

### ISOLATING THE HORIZONTAL AMPLIFIER

When you were performing the procedures to Isolate the faulty section, you had two major conditions that indicated a fault in the Horizontal Section. One condition was the presence of a dot on the display instead of a sweep. The other was a dot on the display that you could only see by pressing the BEAM FINDER. Both of these conditions indicated faults in the Horizontal Section. The following procedures and tips will help you isolate a fault within the section.

In keeping with the successive approximation method of troubleshooting, you must divide and test the Horizontal Section at about the midpoint of the section. This is quite simple in the oscilloscope because the two major sub-sections of the Horizontal Section perform such different functions, one is a generator and the other is an amplifier. This facilitates ease of further fault isolation.

On most oscilloscopes, you can easily isolate the two sub-sections by checking the signals at the rear panel "A" SWEEP OUTPUT and the SWEEP GATE OUTPUT. If both of the output signals are present and appear to be normal, the problem is probably located in the Horizontal Amplifier. If one or both of the signals is missing or incorrect, the problem is in the Timebase.

NOTE: When making this check, ensure that the front panel controls are set up according to the Preliminary Front Panel Set-up presented in the front of this book. Make sure that you have the Trigger Mode in FREERUN or AUTOMATIC.

You can also isolate the two sub-sections another way on those oscilloscopes that have "X-Y MODE" capabilities. First, make sure that all horizontal and vertical position controls are centered. Rotate the TIME/DIV switch to the "X-Y" position. You should have a dot near the center of the display. If a dot does not appear, the fault is probably in the Horizontal Amplifier. You can verify this further by pressing the BEAM FINDER and observing the display. If you get a centered dot, the problem may be in the Timebase or in the CRT Section. If you get a dot that is deflected to either side of the display, the fault is probably located in the Horizontal Amplifier.

## TROUBLESHOOTING THE HORIZONTAL SECTION

You can verify the fault location after removing the cover from the instrument. Set the front panel controls according to the Preliminary Front Panel Set-up in the section of this book on ISOLATING THE FAULTY SECTION. Use a shorting strap to common mode the paraphase amplifier at the input of the Horizontal Amplifier.

NOTE: In some instruments, the Horizontal Amplifier is located on a board that makes access difficult. Be very careful when common moding the amplifier stages and making other tests on the board to prevent personal injury and further damage to the instrument while troubleshooting.

If the display is a horizontally positioned dot, the fault is in the Timebase sub-section and you should refer to the following section on ISOLATING FAULTS IN THE TIMEBASE. If the beam is still deflected horizontally to the edge of the display, the fault is in the Horizontal Amplifier and you can isolate the fault by using the same procedures and techniques described in TROUBLESHOOTING THE VERTICAL SECTION.

### Lab Instruments Oscilloscope Tips and Procedures

This step is easy in the Laboratory Oscilloscopes. If you have a failure in the Horizontal Section of the instrument, swap the Horizontal Timebase with a Timebase that is known to be good.

If the horizontal display is normal as a result of swapping the plug-ins, the problem is probably in the Horizontal Timebase that was removed. If you suspect the fault is in the timebase, refer to the section of this book on ISOLATING FAULTS IN THE TIMEBASE.

If you still do not have a display after swapping the plug-in, the problem is probably in the mainframe and can now be further isolated to the Horizontal Interface Board (if applicable), the Horizontal Amplifier, the CRT, or in the connections between them. If you have no sweep but the CRT Readout is normal (ensure that the READOUT MODE Switch is in the FREERUN position), the fault is probably in the Interface Board. If you have neither display nor Readout, the problem is probably on the Horizontal Amplifier Board or in the CRT. In either case, the location of the fault can be verified by one, or both, of the two following methods.

## TROUBLESHOOTING THE HORIZONTAL SECTION

The first method is to use a shorting straps to common inode the input of the Horizontal Board using the technique described in the Vertical Section of this book. The signal is push-pull coupled from the Horizontal Interface Board (or plug-in) to the Horizontal Amplifier. Use a shorting strap to short the push-pull signal together at the input of the amplifier. The resultant display should be a dot near the center of the display. If the dot does return to the center of the display, the fault is in the Interface or input connection to the Horizontal Amplifier. If it does not return, the problem is in the Horizontal Amplifier.

NOTE: There are two things to remember if you use this technique. First, ensure that all vertical and horizontal position controls are centered before performing this procedure. The second is that, on some instruments, the CRT Readout may become compressed to dots at the top and bottom of the CRT when you short the input to the board.

The second method of verifying this fault isolation is to use an oscilloscope. Connect the probe of a test oscilloscope to one of the legs of the push-pull input to the Horizontal Amplifier Board. The signal should be a positive or negative going ramp of about 265 mV in amplitude. This equates to the standard of 25 mV/Div of deflection used in most Tek Lab Instruments. After you have measured one side of the signal input, place the probe on the other input and you should measure a 265 mV ramp of opposite polarity to the first leg measured. If either of the inputs are missing or appreciably lower than 265 mV in amplitude, the problem is in the input to the board. If both of the input signals are good, the problem is in the Horizontal Amplifier Board.

After you have isolated the fault of this far, you are essentially down to the circuit level of troubleshooting. Use the same techniques to troubleshoot this circuitry that was described earlier for TROUBLESHOOTING THE VERTICAL AMPLIFIER.

## TROUBLESHOOTING THE HORIZONTAL SECTION

### Typical Horizontal Problems

**Problem:** Sweep length decreases at fast sweep speeds. Nonlinearity and sometimes sweep compression to the right.

**Solution:** This problem is typically caused by an open collector load to one of the stages.

An open decoupling resistor will also cause this problem.

**Problem:** Compression or expansion of the sweep as it is positioned from one side to the other.

**Solution:** This problem is typically caused by the diode network between the bases of the amplifier. Check for leaky diodes.

**Problem:** Horizontal sweep control center position is shifted and control is nonlinear.

**Solution:** Check for an open circuit in the center tapped load resistors of the output amplifier.

**Problem:** Nonlinear sweep.

**Solution:** A faulty input emitter follower may also cause the problem.

Check for leaky capacitors and transistors in the input circuitry.

**Problem:** Position range off-centered.

**Solution:** Check the input compensated divider of the input pre-amplifier.

## TROUBLESHOOTING THE HORIZONTAL SECTION

### ISOLATING FAULTS IN THE TIMEBASE

Troubleshooting faults within an amplifier section (vertical or horizontal) of an oscilloscope is pretty straight-forward since a signal is usually processed straight through the circuitry. This means that there are usually no loops or feedback paths within the amplifier sections to compound the troubleshooting process. Therefore, the successive approximation method of fault isolation works very efficiently.

This is not true for the Timebase section because the circuitry within the Timebase does form a loop. Trying to use the successive approximation method to troubleshoot a Timebase is something like trying to find the mid-point around the edge of a circle. However, if you establish a starting point along the edge of the circle, you can easily find a corresponding mid-point. Notice that the key here is to establish a reference point from which to start. This is also the key to troubleshooting the Timebase.

Many technicians have trouble isolating faults within the Timebase of an instrument because they try to troubleshoot the circuitry without having a thorough understanding of the loop concept. The best way to troubleshoot the Timebase is to troubleshoot the "sequence" of events needed to generate the sweep. This "sequence" is predictable and repeatable, and has many events that can be easily identified by the technician. Learn this sequence and its identifiable events and you can easily apply the troubleshooting methods and procedures presented in the first section of this book.

Keep the following in mind as you progress through the remainder of this section:

WHEN ISOLATING FAULTS WITHIN THE TIMEBASE,  
TROUBLESHOOT THE SEQUENCE -- NOT THE CIRCUITRY.

## TROUBLESHOOTING THE HORIZONTAL SECTION

### Timebase Sequence

The first thing to do in troubleshooting the Timebase is to establish a reference starting point. For this sequence, consider the starting point to be the "Quiescent" period, the interval starting right at the end of Hold-Off -- this will be the reference point for all other events in the sequence. The outline that follows will identify the events in the sequence by name, definition, and characteristics. Refer to the "A" Sweep Sequence Diagram on the following page to see the position of each event in the sequence. Notice that the events are listed in the order of their occurrence within the sequence.

NOTE: You can observe some of these events better if you operate the oscilloscope in the SINGLE SWEEP MODE of operation. Before continuing, set the TIME/DIV to 1 S/DIV, "A" SWEEP, SINGLE SWEEP and INTERNAL TRIGGER.

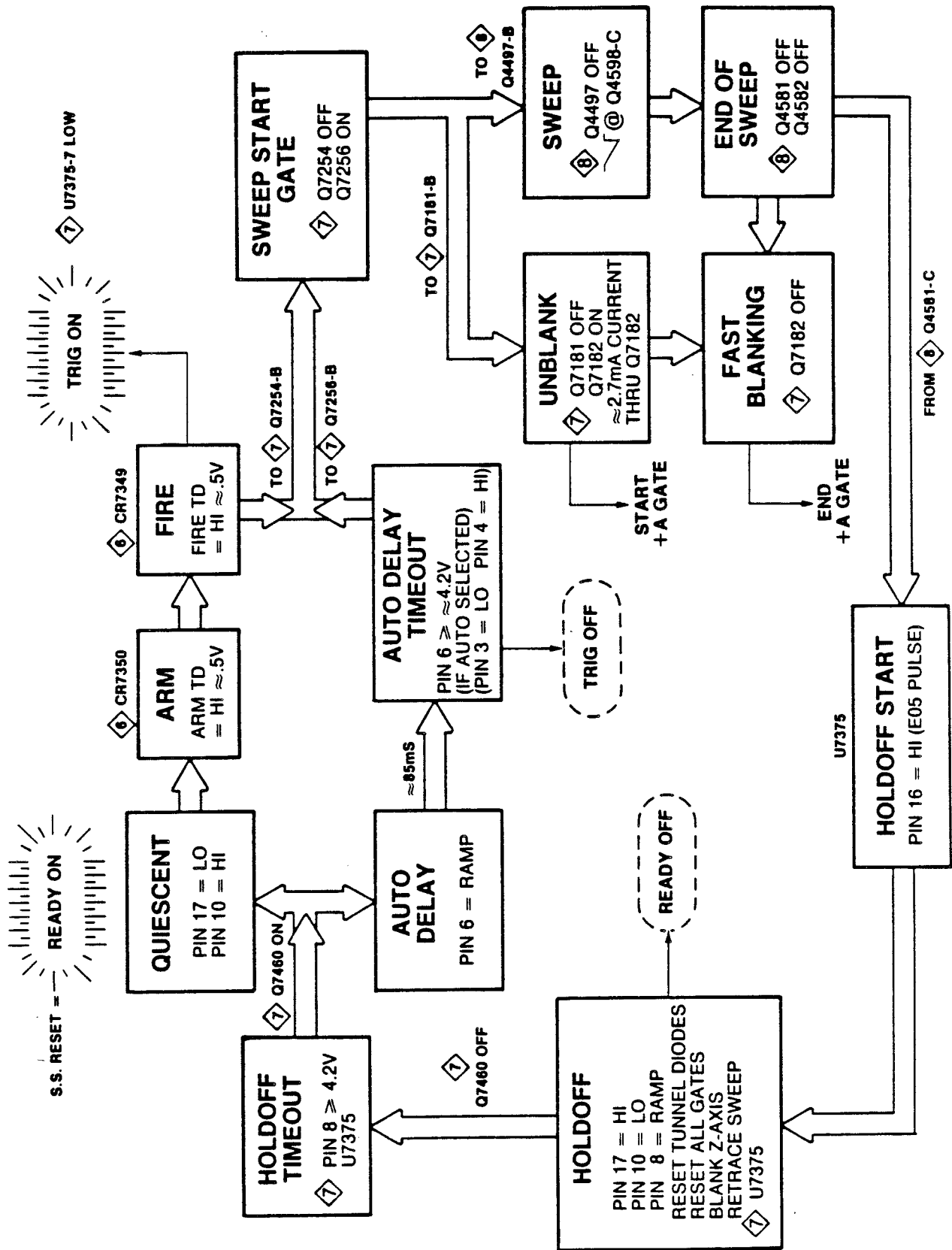

465B 'A' SWEEP SEQUENCE

## TROUBLESHOOTING THE HORIZONTAL SECTION

NOTE: Where applicable, there is a KEY INDICATOR for each of the events in the sequence. This KEY INDICATOR points out a predicted occurrence that you should be able to observe on the display or on the front panel indicators.

### EVENT

### DEFINITION/CHARACTERISTICS

#### QUIESCENT PERIOD

This is the reference starting point. It is the interval between HOLD-OFF and Trigger. This state occurs when HOLD-OFF has timed out and ended, and the instrument is now waiting for a Trigger.

KEY INDICATOR - The READY indicator will illuminate when the instrument is in this state and the instrument is in the SINGLE SWEEP MODE. (Verify this on the A SWEEP SEQUENCE FLOWCHART.) Set the TIME/DIV control to 1 S/div, select SINGLE SWEEP. Press the SINGLE SWEEP RESET button to arm it. The READY light should turn on.

You can also observe this state by checking the state of the Tunnel Diodes (if applicable). Both diodes should be in the Low state (less than 100 mV on the Anode) and HOLD-OFF should be inactive.

#### ARMED

The Trigger circuit is Armed and is ready to generate a trigger. If the TRIGGER SLOPE is set for a positive (+) trigger, the circuit will be ARMED (qualified) by the first negative (-) trigger signal occurrence in the QUIESCENT PERIOD.

You can set this condition when the scope is in the SINGLE SWEEP MODE. Set the TRIGGER SLOPE to + (positive) slope and rotate the LEVEL control fully clockwise. Press the SINGLE SWEEP RESET then rotate the LEVEL control slowly counterclockwise to its stop. The Trigger is now ARMED.



## TROUBLESHOOTING THE HORIZONTAL SECTION

### EVENT

### DEFINITION/CHARACTERISTICS

ARMED (Cont.)

You can test this state in those scopes with Tunnel Diodes in the Trigger Generator. Connect the test probe to the anode of the ARM Tunnel Diode. There should be about 400-500 mV at the anode of the diode. If not, check the Tunnel Diode and the Tunnel Diode Driver Circuitry.

In those instruments with an integrated Trigger Generator, you cannot test this step.

FIRE

This is the Trigger from the Trigger Generator. The output from the circuit may be called Trigger, Sweep Gate, or Main Gate. It may also have an Auto Disable Gate. This occurrence signifies that the Trigger Generator has processed a signal of the correct polarity and amplitude, as set by the front panel controls.

In the previous step of the sequence you ARMED the Trigger Generator. Now that you have it armed, you can FIRE it by rotating the LEVEL control clockwise.

KEY INDICATOR -- If the instrument Triggers properly, the TRIGGERED light will illuminate. (Note this on the A SWEEP SEQUENCE FLOWCHART.)

The Trigger Pulse (Sweep Gate) will be sent to the Sweep Generator and to the Sweep and Z-Axis Logic sections. This state will also disable the AUTO capabilities of the sweep Logic Circuitry.

## TROUBLESHOOTING THE HORIZONTAL SECTION

### EVENT

### DEFINITION/CHARACTERISTICS

#### FIRED (Cont.)

On those scopes with Tunnel Diodes (TD), you can check this state by connecting a test probe to the anode of the FIRE Tunnel Diode. If the TD is fired, the output voltage will be 400-500 mV. If the voltage is not up to this level, the TD has not fired. Check the Tunnel Diode and the Tunnel Diode Driver circuitry.

On the instruments with integrated Trigger Generators, measure the output of the Trigger Generator IC for the proper trigger level. This trigger waveform specifications are usually provided in a Voltage and Waveform Chart located in the Maintenance Section of the Service Instruction Manual.

#### SWEEP START GATE

This is the output of the Sweep Start Comparator. The Trigger from the Trigger Generator is processed through the Sweep Start Comparator to ensure a proper trigger output level. This gate drives the Sweep Generator and the Unblinking Gate Generator.

KEY INDICATOR -- If the TRIGGERED light is illuminated but you still do not have a display, press the BEAMFINDER. If the display is a dot that is "stuck" to the left side of the display, and it can only be seen by pressing the previous stages. The TRIGGERED light indicates that the FIRE has been completed, so the fault is probably in the Sweep Start Comparator. This is true only if the sweep has not run.

If the sweep is in any other condition, the problem is elsewhere.

## TROUBLESHOOTING THE HORIZONTAL SECTION

### EVENT

### DEFINITION/CHARACTERISTICS

#### UNBLANK

This event in the sequence is marked by the generation of the gate logics necessary to unblank the CRT at the beginning of sweep. The UNBLANK gate provides the unblanking logic to the Z-Axis Amplifier to turn on the beam in the CRT.

KEY INDICATOR -- After the UNBLANK event has occurred, you can see the display without having to press the BEAM FINDER. The CRT will have a visible trace or spot.

If the display is a sweep that can only be seen by pressing BEAM FINDER, the fault is probably in the Unblank Amplifier or in the CRT and Z-Axis Section.

In many oscilloscopes, the gate generator for the unblanking logic also generates the "A" GATE that is available to the rear panel connector of the instrument. Check the schematics and measure the output of the A GATE OUTPUT, if applicable.

#### SWEEP

The generation of a linear ramp to drive the Horizontal Section. The sweep polarity and amplitude varies from scope to scope, so the ramp may be either positive or negative in transition. As the ramp runs through its voltage transition, it drives the beam from left to right on the CRT.

KEY INDICATOR -- If a dot appears on the left side of the CRT that is visible with normal intensity and without the use of the BEAM FINDER, the SWEEP is locked up. Look for this fault in the Sweep Generator.

## TROUBLESHOOTING THE HORIZONTAL SECTION

### EVENT

### DEFINITION/CHARACTERISTICS

If the SWEEP is locked up on the left side of the CRT, you can test the Sweep Generator by removing the Disconnect Transistor in the Sweep Generator. If the SWEEP runs, the Sweep Generator is working; look for a fault in the input gating. (For those instruments with components that are soldered in, you can turn the Disconnect Transistor off by shorting the Emitter-Base junction. Be careful when trying this, since a misconnection could cause catastrophic failure.)

### END OF SWEEP (EOS)

The ramp voltage is compared to a fixed voltage that correlates the beam deflection to the far right side of the CRT. The comparison of these two voltages signifies the end of the sweep. This event tells the Timebase to Blank the CRT and to initiate the retrace/reset operation.

KEY INDICATOR -- If the SWEEP runs one time across the CRT and the CRT is blanked upon reaching the right side, this section is operating normally.

KEY INDICATOR -- If a dot appears on the right side of the CRT without the use of the BEAM FINDER, this step has not been completed, though the SWEEP has ended. You can verify the location of the fault by checking the ramp voltage with a scope or by causing the End of Sweep Comparator to disconnect. (Use the same technique described for disconnecting the sweep.)

## TROUBLESHOOTING THE HORIZONTAL SECTION

### EVENT

### DEFINITION/CHARACTERISTICS

#### FAST BLANKING

At the end of the sweep, the CRT is blanked to prevent an intensification at the end of sweep and to prevent visible flyback (sweep retrace). This step provides immediate blanking of the CRT beam without having to wait for the propagation delay in ending all other gates.

KEY INDICATOR -- This step has been completed if there is a dot visible at the right side of the CRT that is visible only upon pressing the BEAM FINDER.

Since this is a function of the unblanking logic, you can measure the result of this at the rear panel of some instruments. Check the A GATE OUTPUT at the rear panel signals out connectors. If the gate is still high, this step has not been completed. If the gate has ended, then FAST BLANKING should have been completed.

#### HOLDOFF START

After the end of sweep has been detected, a pulse is generated to initiate the HOLDOFF cycle. This pulse is usually taken directly from the End of Sweep Detector, though in some instruments it may be amplified, inverted, or buffered. In most Tektronix oscilloscopes, this pulse is a positive (+) pulse that is fed back to the Sweep and Z-Axis Logic Circuit. According to the oscilloscope, this HOLDOFF START Pulse may be called H-O START, A SWEEP RESET, or GATE RESET.

In those instruments that use the Tek-made Sweep Control IC (P/N 155-0049-XX), the HOLDOFF START Pulse is applied to input pin #16 of the IC to initiate HOLDOFF. This should be a very narrow pulse with a low of about 0 Vdc and a high of about +4.3 Vdc.

## TROUBLESHOOTING THE HORIZONTAL SECTION

### EVENT

### DEFINITION/CHARACTERISTICS

#### H-O START (Cont.)

Check the HOLDOFF START Pulse with a test oscilloscope. It should step high just as the sweep reaches the right side of the CRT. If no pulse is present, check the output of the End of Sweep Comparator. If the HOLDOFF START goes high (active) and remains high, the circuit is locked up -- check the HOLDOFF and TRIGGER circuits.

#### HOLDOFF (H-O)

This is the time interval and event in which the sweep and all gates are reset. HOLDOFF is a timed event. It is controlled by an R-C Timing circuit, and the time delay is usually dependent on the sweep TIME/DIV control.

KEY INDICATOR -- When HOLDOFF has been initiated, the READY indicator on the front panel will go out.

This is a very active interval in the sweep sequence. During this time, the Trigger Generator will be reset and disabled so that it cannot accept another trigger signal. The circuitry in the Trigger Generator is being held off -- hence the name HOLDOFF. During this interval, all gates are reset, the CRT is blanked, and the sweep is retraced.

In instruments that utilize the Tek-made Sweep Control IC (155-0049-XX), you can test the operation of the circuitry during this interval by looking at the pin activity on the IC. During this interval, H-O (pin 17) should be high, H-O Notted (pin 10) should be low, and H-O TIMING (pin 8) should be ramping up from 0 Vdc.

## TROUBLESHOOTING THE HORIZONTAL SECTION

### EVENT

### DEFINITION/CHARACTERISTICS

#### HOLDOFF TIMEOUT

This event marks the end of HOLDOFF. HOLDOFF timing is a function of an R-C timing network that is controlled by the TIME/DIV control. The timeout is proportional to the sweep speed to insure that HOLDOFF is long enough to allow all of the sweep timing capacitors to fully discharge before another sweep is initiated. When the charge on the timing capacitor in the H-O Timing R-C reaches a predetermined level, HOLDOFF is reset (ended) and the instrument enters the QUIESCENT state again.

To check this event on instruments that use the Tek-made Sweep Control IC (155-0049-XX), measure the voltage at the H-O TIMING input (pin 8) of the IC. If the voltage is greater than 4.2 Vdc, HOLDOFF TIMEOUT is complete.

You can also check to see if the instrument entered the QUIESCENT state of the sequence as it should have. Check H-O (pin 17) of the IC for a low, H-O Notted (pin 10) for a high, and H-O TIMING (pin 8) for a low. Pin 8 of the IC will be low again because the R-C timing capacitor is internally discharged by the IC.

Check other things from the TIMEBASE, such as rear panel GATE OUTPUTS, that will verify that HOLDOFF TIMEOUT has occurred. Also check to see that the Tunnel Diodes (if applicable) have been reset.

Even though you have completed the loop around the sweep sequence, you are not finished. Notice that there are two steps, AUTO DELAY and AUTO DELAY TIMEOUT, that go to the inside of the loop. Even though these two steps are only used functionally when the instrument is in the AUTO TRIGGER MODE, they can still provide you with indicators and test points that can indicate the health of the circuitry.

## TROUBLESHOOTING THE HORIZONTAL SECTION

Even though the scope is operating in the SINGLE SWEEP MODE, the two AUTO operations can provide you with a powerful troubleshooting tool. Refer to the A SWEEP SEQUENCE FLOWCHART again and notice the KEY INDICATOR for the FIRE event. When the Trigger occurred, the front panel TRIGGERED indicator was lit. Notice also that the indicator has not been turned off yet. The TRIGGERED light is usually turned off as a result of the operation of the AUTO events.

After HOLDOFF has ended, the instrument enters the QUIESCENT state in which it is now waiting for a trigger. Normally, if no trigger is received and processed, the oscilloscope will remain in this state and no sweep will be generated. However, if a trigger is not received within about 100 mS when the scope is operated in the AUTO Trigger Mode, the Timebase will initiate an AUTO Trigger. This will cause an Auto Sweep to occur. This gives the operator a bright baseline to check the operation of the scope, and to see if any trigger signals are present. When in the AUTO Mode, the Timebase will cause the sweep to freerun until a trigger is received to disable the AUTO function.

### EVENT

### DEFINITION/CHARACTERISTICS

#### AUTO DELAY

This is the waiting interval of the QUIESCENT period in which the instrument is waiting for a trigger. This is a timed event whose interval is controlled by an R-C Timing Circuit.

When a trigger is received and the FIRE event is completed, the AUTO TRIGGER Mode is disabled by the Auto Disable Gate from the Trigger Generator. This discharges the AUTO DELAY Timing Network and holds it discharged until the end of the following HOLDOFF.

If a trigger is not received the AUTO DELAY circuitry will begin charging up at the end of HOLDOFF. This charging time is the delay (waiting time) before a sweep is automatically generated.



## TROUBLESHOOTING THE HORIZONTAL SECTION

### EVENT

### DEFINITION/CHARACTERISTICS

You can observe this event on instruments that use the 155-0049-XX Sweep Control IC, but you must have the oscilloscope triggered to see the normal operation of the circuit. Connect the test probe to the AUTO DELAY input (pin 6) of the IC. You should see a shallow ramp on pin 6 of the IC. Vary the frequency of the input trigger signal and observe the change to the ramp; notice that the amplitude and duration change as the input trigger signal is varied.

**AUTO DELAY TIMEOUT** This event marks the end of the waiting period. When the charge on the AUTO DELAY timing capacitor reaches a pre-determined level, TIMEOUT is detected. After the delay is completed, a gate is generated that will initiate an automatic sweep. Once the capacitor is charged and AUTO DELAY TIMEOUT has occurred, the capacitor will remain charged until a trigger is received by the Trigger Generator. This means that there will be no waiting period at the end of the next sweep and holdoff interval.

**KEY INDICATOR** -- (the following is true for most Tek oscilloscopes, however some of the newer scopes do not comply.) At the end of the AUTO DELAY TIMEOUT, the TRIGGERED light will be turned off. This function still operates even in the SINGLE SWEEP Mode of operation. If the TRIGGERED light comes on and then goes off again when you initiate the sweep sequence, it signifies that the entire sequence has been completed and that the Timebase is operating properly.

## TROUBLESHOOTING THE HORIZONTAL SECTION

### EVENT

### DEFINITION/CHARACTERISTICS

AUTO DELAY TRIGGER (Cont.) Again, you can easily verify the occurrence of this event in two ways on scopes that use the 155-0049-XX Sweep Control IC. If it has occurred properly, the TRIGGERED light should be off. The AUTO DELAY input to the IC is level sensitive and should activate AUTO when the charge at pin 6 becomes greater than +4.2 Vdc. If the charge on pin 6 is not greater than +4.2 Vdc, with no trigger applied in the NORMAL Trigger Mode, there is a problem in the AUTO DELAY R-C Timing Network. If the charge at pin 6 is at the correct level, the IC should generate an auto gate to initiate a sweep. The AUTO GATE (pin 4) should be high or the INVERTED AUTO GATE (pin 3) should be low to initiate a sweep. If the AUTO DELAY level is correct but no gate is generated, check the IC.

The A SWEEP SEQUENCE FLOWCHART that we have been using for a reference has been intentionally generic to fit the normal operation of most Tek scopes. The SWEEP SEQUENCE FLOWCHARTS on the following pages are for specific instruments. Study them carefully and compare them to the circuit operation of the scopes for which they are indicated. After you understand the sequence, you may want to explore the operation of other oscilloscopes and generate more of the sequence charts for the other scopes.

465 "A" SWEEP SEQUENCE

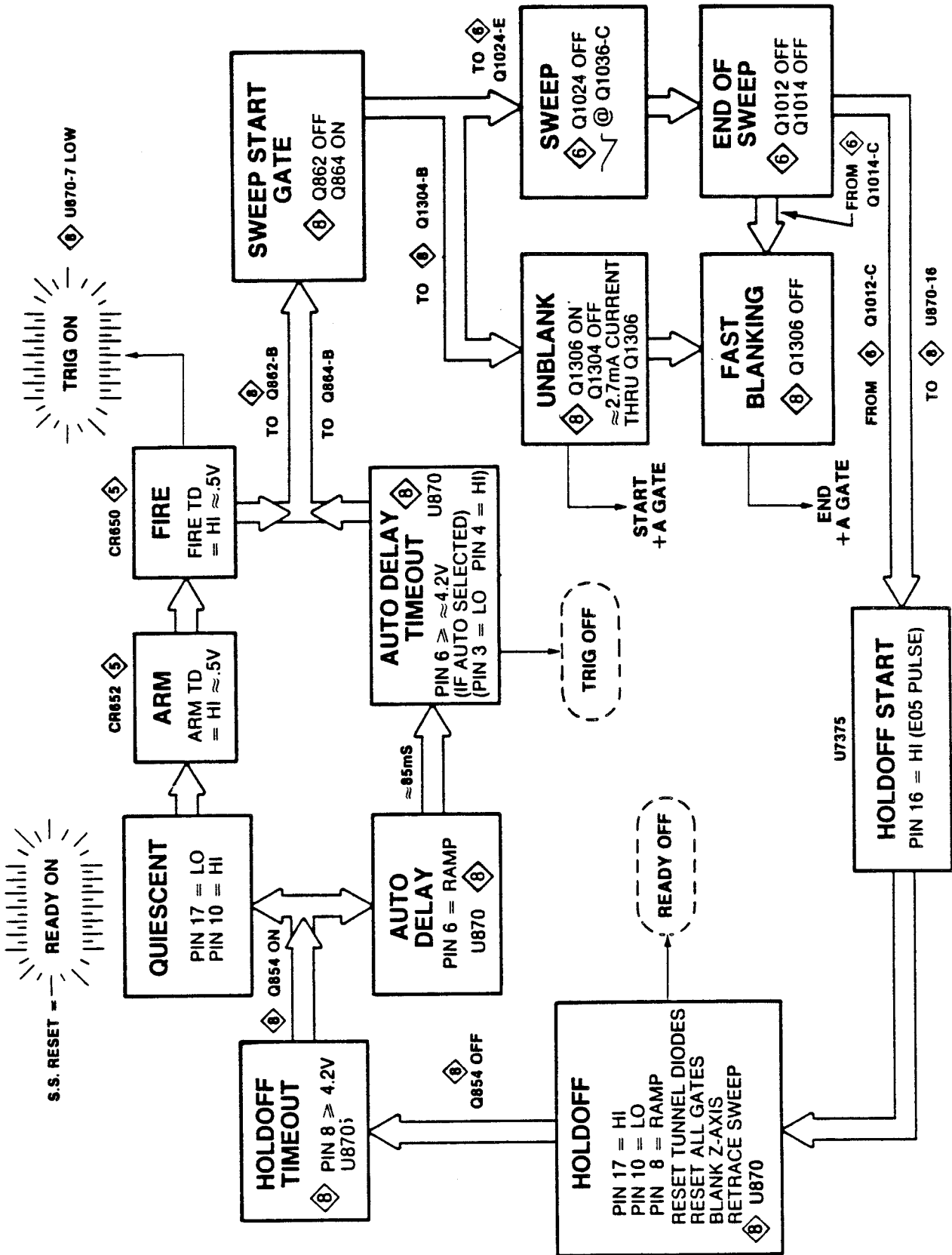

465 'A' SWEEP SEQUENCE

465B "A" SWEEP SEQUENCE

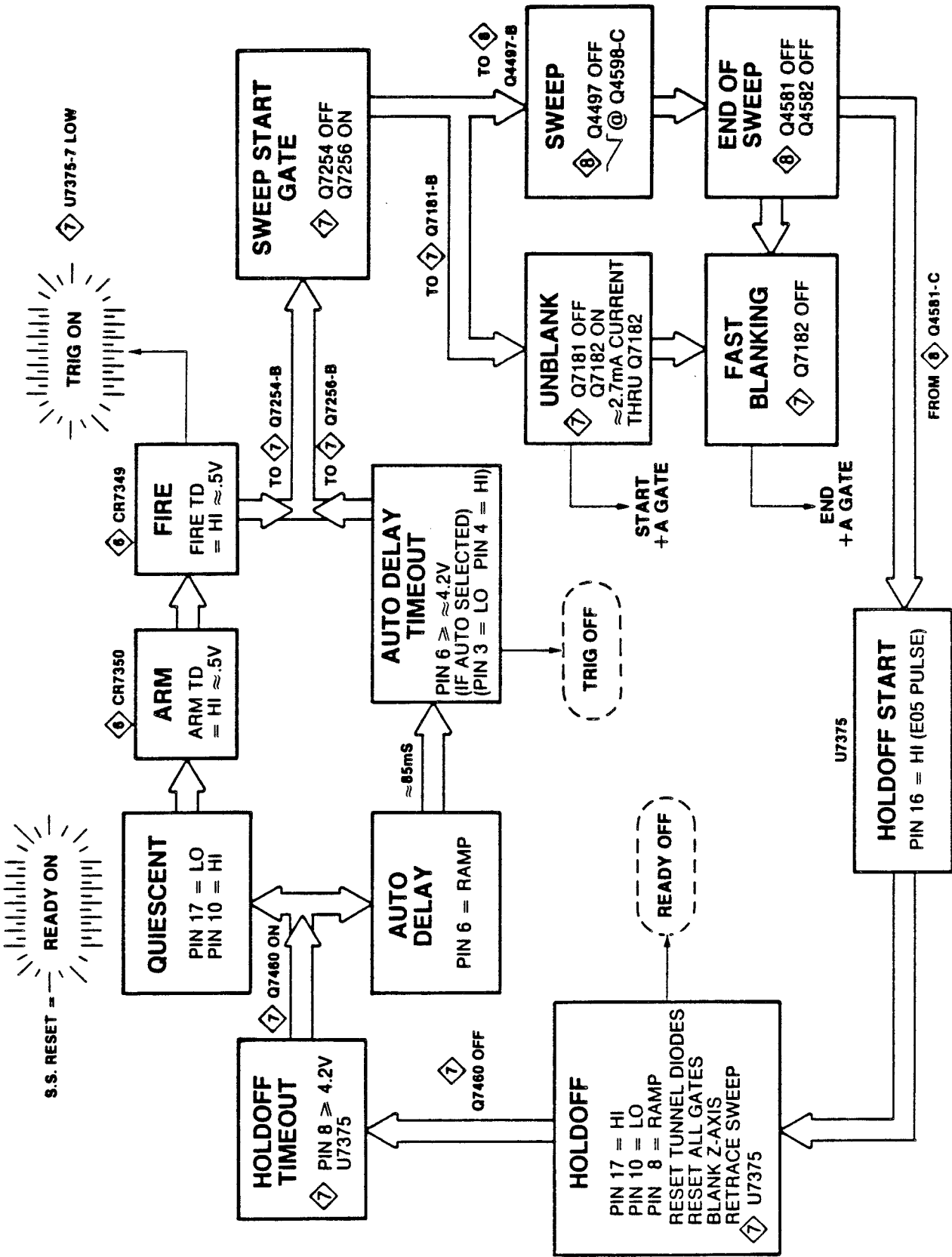

465B 'A' SWEEP SEQUENCE

TROUBLESHOOTING THE HORIZONTAL SECTION

475A "A" LOCKED KNOBS FAST

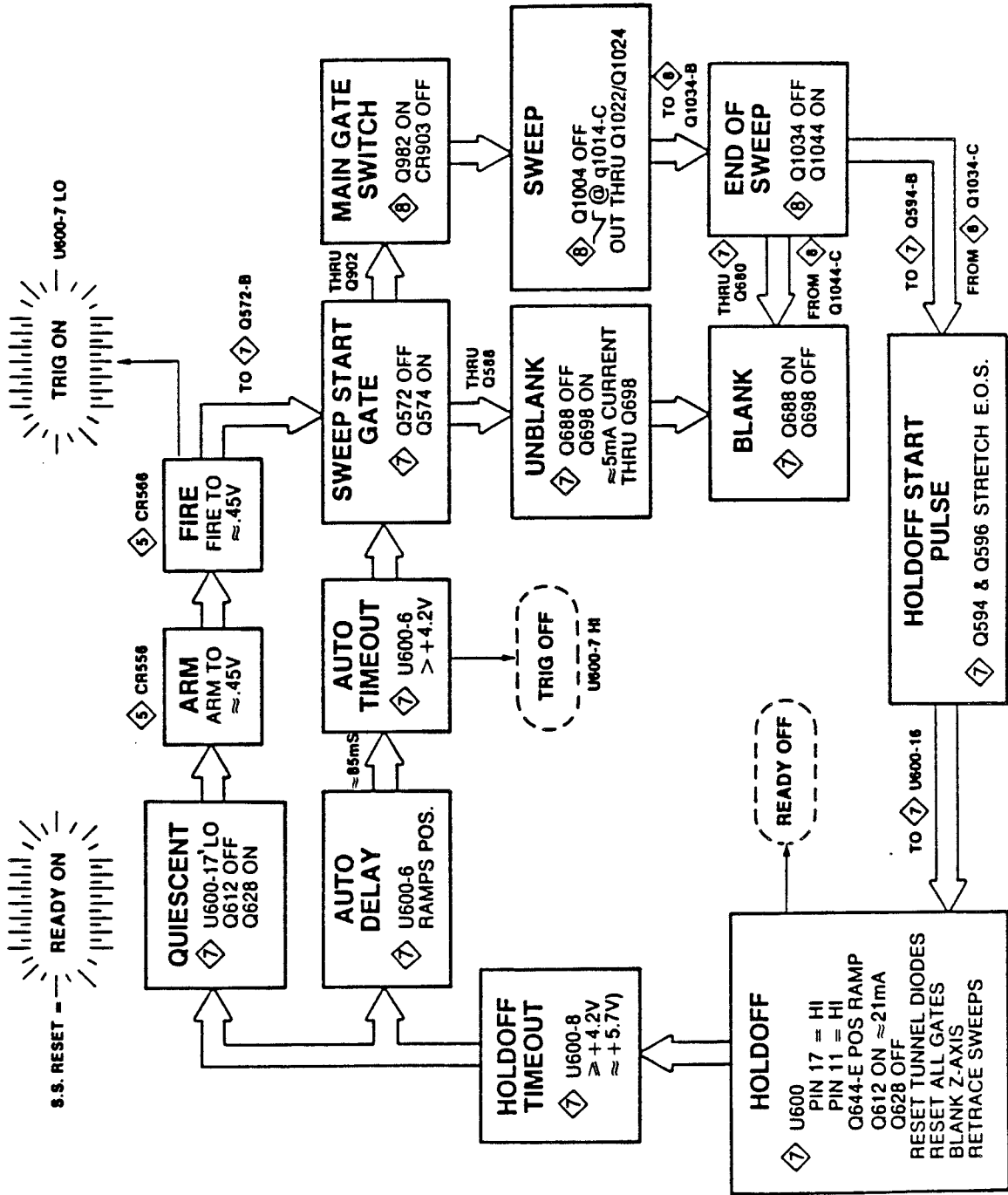

475A 'A' LOCKED KNOBS FAST (≈ 5μS/DIV)

TROUBLESHOOTING THE HORIZONTAL SECTION

475A "A" LOCKED KNOBS SLOW

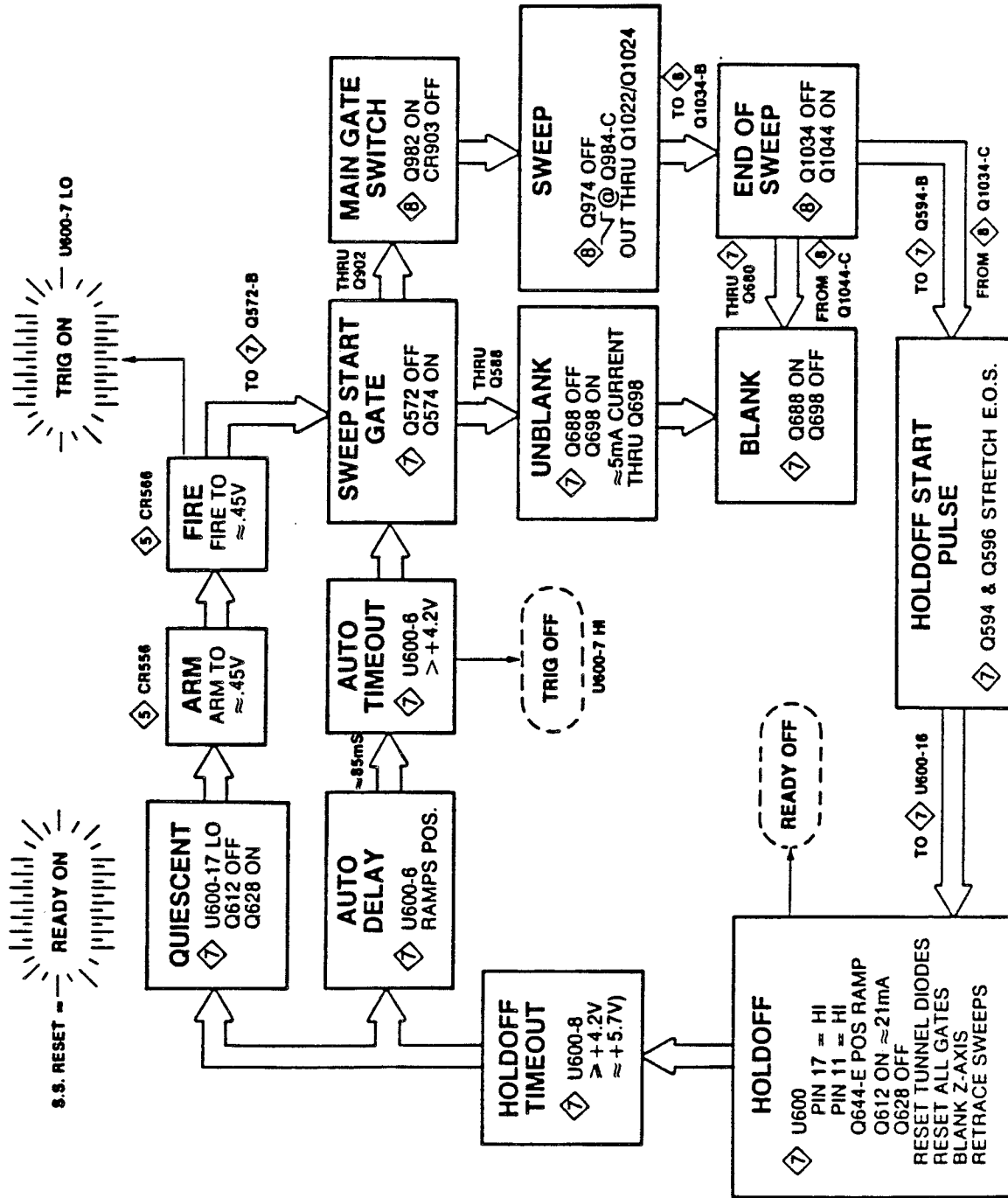

475A 'A' LOCKED KNOBS SLOW ( $\approx 1\mu\text{s}/\text{DIV}$ )

TROUBLESHOOTING THE HORIZONTAL SECTION

475A "A" UNLOCKED KNOBS OR "A" INTENSIFIED

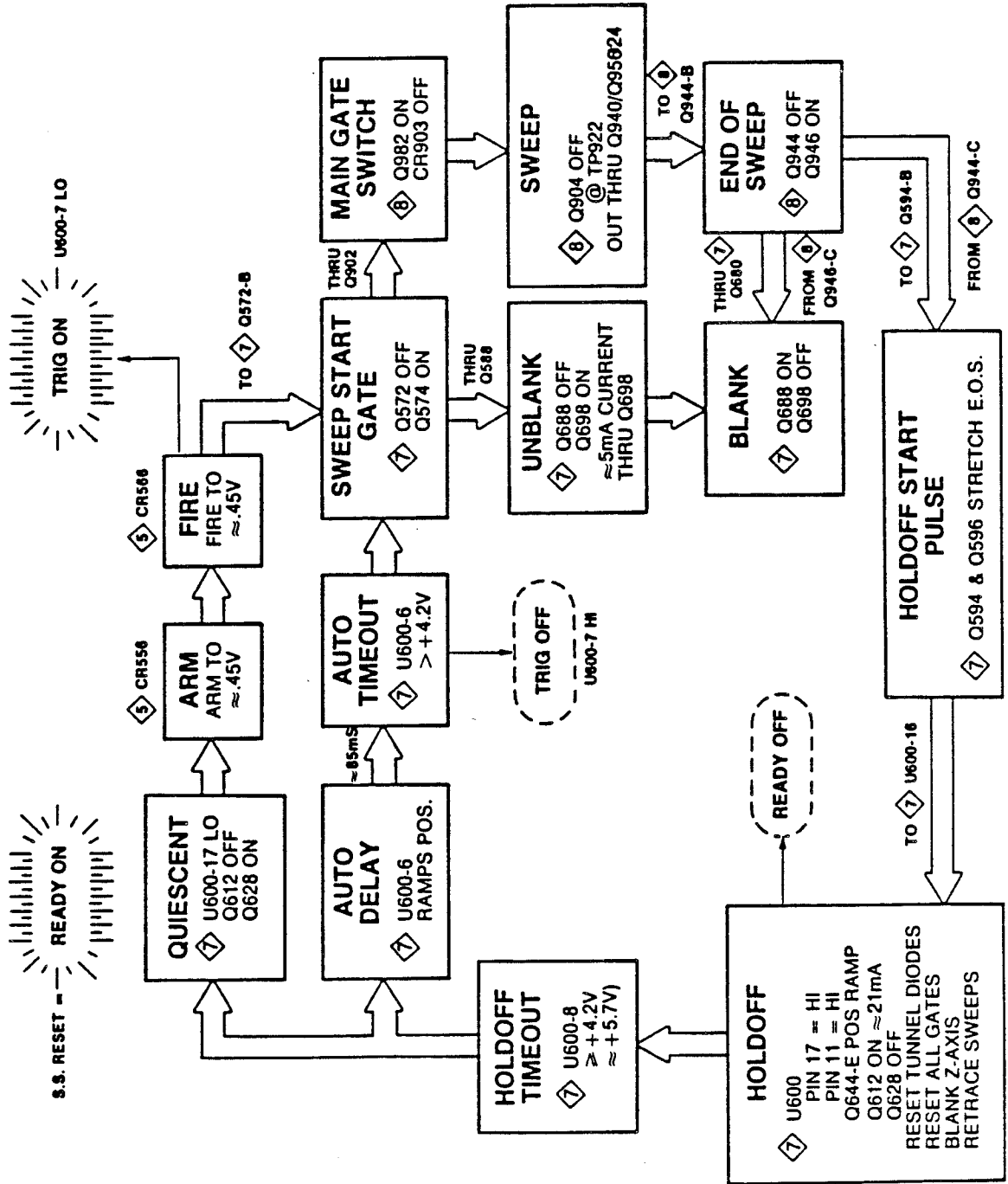

475A 'A' UNLOCKED KNOBS OR 'A INTENSIFIED'

## TROUBLESHOOTING THE HORIZONTAL SECTION

### Tips for Troubleshooting Trigger Circuits

When troubleshooting a new trigger circuit, take some time to familiarize yourself with the block diagram and schematics. Spending a few minutes with the instrument manual can give valuable insight into the problem.

Tektronix trigger circuits are designed to respond to a wide variety of input signals. Since many of these input signals are unsuitable as sweep-initiating triggers, signals are first applied to a trigger circuit where they are converted to a pulse of uniform amplitude and shape. Thus, regardless of the input signal, it is possible to start the sweep with a pulse that has constant amplitude and risetime. The trigger circuitry allows the operator to start the sweep on either slope of the waveform, select any voltage level on the rising or falling slope of that waveform, and filter out selected frequencies of the input signal for greater ease and stability in triggering.

The triggering of the general purpose oscilloscope may be broken down into five basic parts: (1) vertical amplifier trigger pickoff circuitry, (2) input coupling circuitry, (3) input amplifier, (4) trigger pulse generator, and (5) automatic triggering circuitry.

The trigger pickoff circuitry acts as a buffer to keep the trigger circuitry from changing the operation of the vertical amplifier, yet pass the amplified vertical signal to the trigger circuit with minimum distortion. Input coupling circuitry allows selection or rejection of various frequency components of the trigger signal. The input amplifier provides gain to assure the trigger pulse generator of sufficient input for proper circuit operation. The automatic triggering circuitry used in Tektronix instruments provides a baseline in the absence of a trigger signal and eliminates control of coupling and level controls.



## TROUBLESHOOTING THE HORIZONTAL SECTION

Although trigger circuits vary in their complexity and sophistication, the essentials are the same in all instruments. Most trigger circuits incorporate a trigger sensitivity control, to permit adjustment of the minimum signal size to which the circuit can respond. The following figure illustrates simplified block diagrams for trigger circuits. Individual trigger circuit designs vary, but all circuits make use of some of the basic functions on the following page.

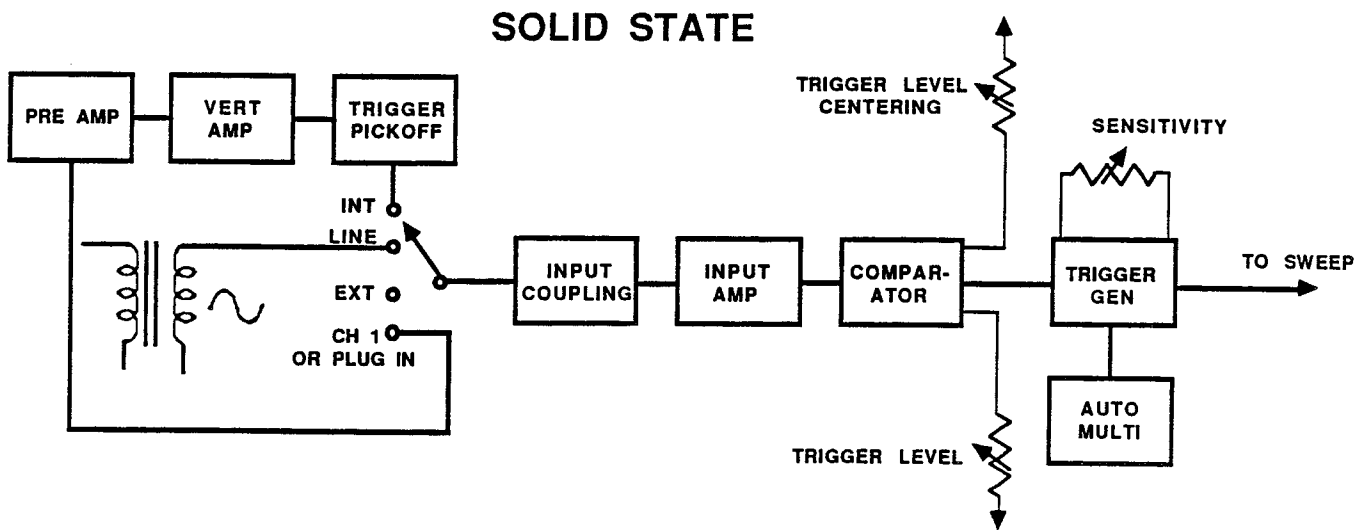

Typical Block Diagrams for Solid-State Trigger Circuits

## TROUBLESHOOTING THE HORIZONTAL SECTION

The basic internal adjustments of a modern oscilloscope are:

1. Trigger level centering adjust -- controls trigger circuit symmetry to enable all coupling modes to work properly with the slope switch.
2. Internal trigger DC level adjust -- allows the center of the LEVEL control to be set exactly to zero volts in the DC mode.
3. Trigger sensitivity -- controls the minimum signal response -- minimum sensitivity limited by noise.

When troubleshooting trigger problems, a few simple steps can often determine which stage of the trigger is at fault. Checking the operation of a trigger circuit using different sources, modes, slopes, and coupling positions will often isolate a problem. Observing the effect the level control gives additional information. In checking trigger circuits, always be sure that sufficient signal is being applied to obtain a large observable deflection (about 1 cm). For instance, set the VOLTS/DIV switch to 100 mV/DIV to a selected vertical then apply a 500 mV signal to the corresponding vertical input.

## TROUBLESHOOTING THE HORIZONTAL SECTION

Varying the trigger SOURCE switch between INTERNAL and EXTERNAL triggering checks the trigger pickoff circuitry. Comparing operation in different trigger modes can usually localize a problem to a specific trigger stage (e.g., noting a difference in operation of the trigger circuit in AUTO or NORM may suggest the faulty stage).

Once the problem has been traced to a specific block, a close visual check may pinpoint the problem. Substituting transistors offers a quick means of checking a suspected problem. Always return the original components to their place after the problem has been cured. In newer model oscilloscope, most components are soldered in place; therefore this practice becomes impractical.

### Tunnel Diode Triggering

Voltages generally measured across a tunnel diode in various states of operation:

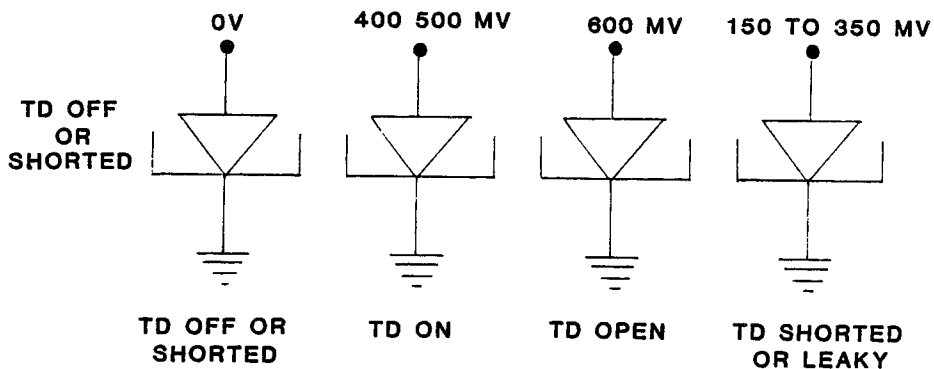

Tunnel Diode Triggering Voltages

## TROUBLESHOOTING THE HORIZONTAL SECTION

A Curve Tracer is very useful to check tunnel diodes in the circuit (in most cases). If there is any doubt of device performance, lift one end and connect test leads directly across the tunnel diode (TD). Set the vertical sensitivity on the Curve Tracer to cover the sensitivity of the diode under test and set the horizontal to .1 V/div. (Typical TDs have a horizontal switching voltage of about .5 volts.) The waveform is not exactly the same as an out-of-circuit check, but in most cases, it indicates whether or not the TD is working properly. Be careful to not apply excessive mechanical strain, excessive heat, or excessive voltage to the TD.

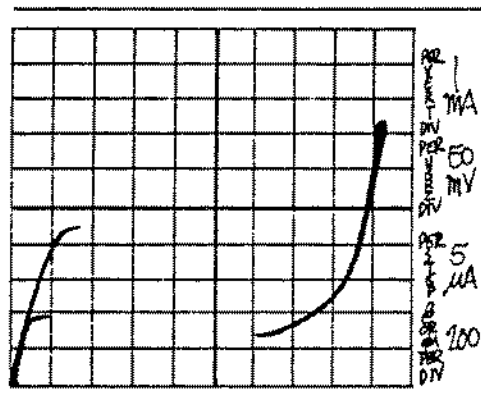

Typical Curve Tracer Display for Tunnel Diodes

Trigger Operation

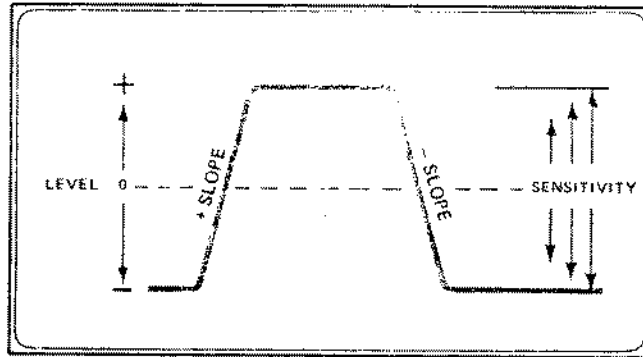

Trigger Level and Slope

A simple method for checking trigger circuit operation is to apply a calibrator signal to the oscilloscope. Using the INTERNAL trigger source, adjust the controls and vertically center at least 1 cm of calibrator signal on the CRT display. Set the LEVEL control to zero and place the coupling control in the AC LF REJECT position. This is typically the most difficult position in which to make trigger adjustments. If the circuit functions properly in this position, you can be assured that the circuitry is good. Set the sweep speed for the appropriate speed to observe 5-10 cycles of the square wave signal. Preset the trigger sensitivity (if there is one) to midrange.

The sensitivity adjustment determines the minimum circuit response (in mV). The trigger level centering assures proper slope and level operation in all coupling modes.

# TROUBLESHOOTING THE HORIZONTAL SECTION

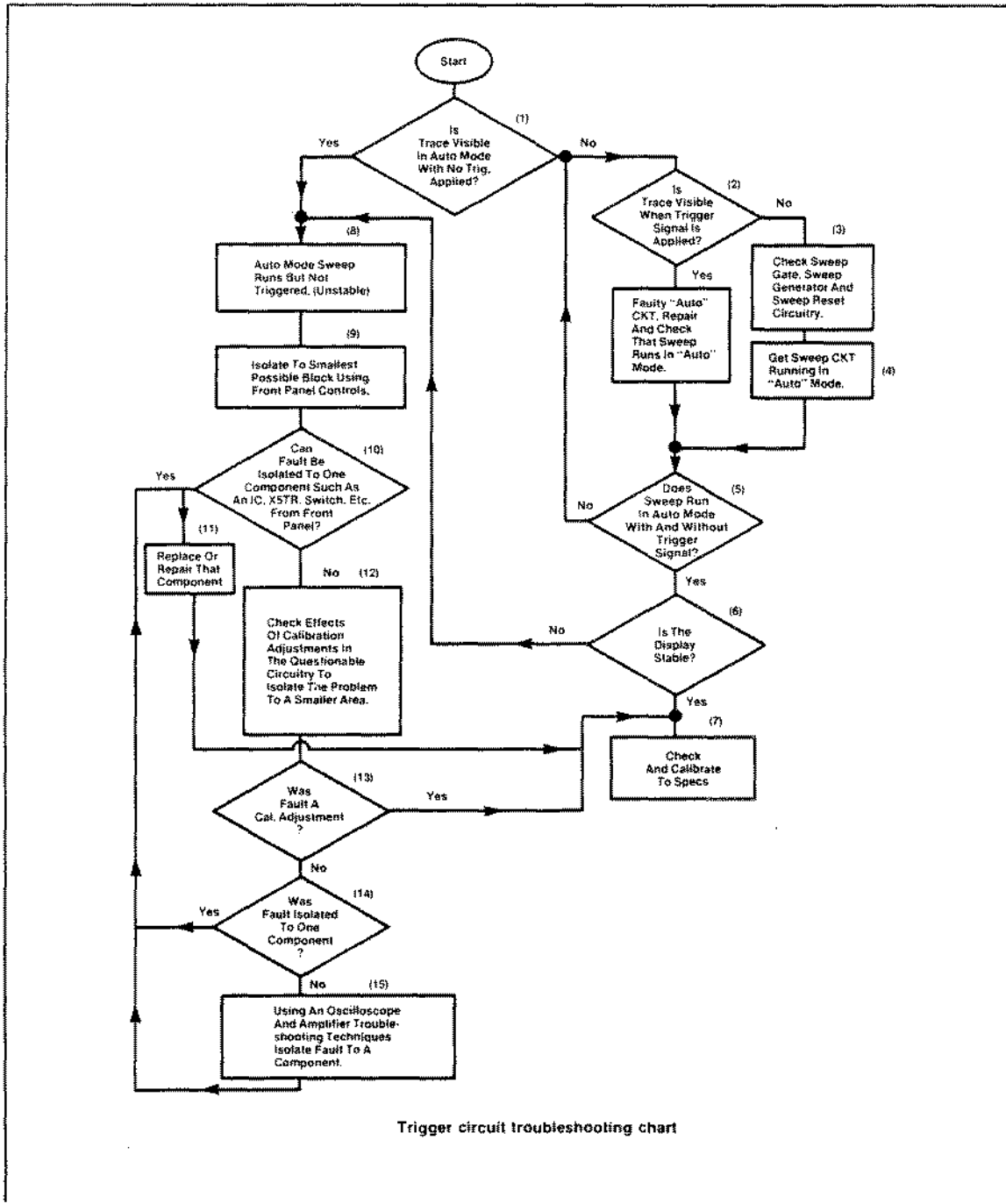

Trigger circuit troubleshooting chart

General Tips for Troubleshooting the Sweep Circuits

Tektronix sweep circuits are designed to develop a linear sawtooth voltage over a wide range of sweep times. Linear sawtooth voltages ensure that the waveform passes through a given number of volts during each unit of time. The sawtooth rate of rise (or fall) is set by the normally calibrated TIME/DIV control. This sawtooth voltage is then processed in the horizontal amplifier and applied to the plates of the CRT, resulting in the horizontal deflection of the electron beam.

As a result, the cathode-ray beam is swept horizontally to the right through a given number of graticule divisions during each unit of time — the rate being controlled by the TIME/DIV control. In this manner, a baseline is produced that is proportional to discrete amounts of time (determined by the TIME/DIV control). A time difference reading is made by measuring the distance between two different horizontal points on the CRT display .

Delaying sweep oscilloscopes are quite common and provide two separate complete sweep systems. The first, or delaying sweep, provides a delayed sweep trigger just prior to the moment when the signal of interest occurs. Generally, a 10-turn multiplier dial used with the TIME/DIV control provides a continuously variable sweep trigger and initiates the delayed sweep at the desired time. Delaying sweep oscilloscopes provide both increased measurement resolution and accuracy.

Modern time-base generators generally consist of five main circuits: a sweep gating multivibrator, a Miller runup (or rundown circuits, sawtooth generator and disconnect diode), holdoff circuitry, sweep lockout circuitry and automatic sweep generator circuitry. In addition, the sweep circuit provides the unblanking signal to the CRT and often a sawtooth and/or gate output on the instrument panel.

Sweep generators make use of operational amplifier techniques to obtain their required linearity. As a result, if circuit problems appear, they are sometimes difficult to troubleshoot because of the feedback loops involved. Usually the feedback loop must be broken in order to localize the circuit problem.

## TROUBLESHOOTING THE HORIZONTAL SECTION

When troubleshooting sweep circuits, free run the sweep to be certain that the trigger circuitry is not inhibiting sweep operation. Gate and sawtooth output connectors provide a quick check of circuit operation and may provide a clue to the problem. If no outputs are observed, check to be certain that trigger inputs are gating the sweep gate circuits.

Holdoff and feedback operation may be checked by monitoring the emitter of the holdoff circuit. Check to see if the holdoff follower follows the action of the sweep length control. These two blocks comprise most of the feedback path and if their follower action is inoperative, the problem is quickly localized.

### Typical Sweep Problems

Sweep shortens at faster sweep speeds.

Check: The sawtooth output emitter follower may be loading the circuit. Remove the sawtooth emitter follower and note whether the problem disappears. If the trouble is not in this stage, then check the output stage of the horizontal amplifier.

Sweep nonlinear at the left side of the CRT.

Check: Faulty holdoff circuit operation may be causing the problem. Check holdoff emitter follower for improper circuit operation.

Sweep shortens on right side of the CRT when sweep is triggered.

Check: An open diode in the positive trigger clipper circuit may inhibit positive clipping of the sweep gate input and cause premature rundown of the sweep.

Sweep tends to free run at different sweep speeds when triggered at other speeds.

Check: Preset stability is misadjusted or lockout multivibrator circuit operation is weak.



## TROUBLESHOOTING THE HORIZONTAL SECTION

Sweep will not run by itself, but will start when shock excited (i.e., rotating the TIME/CM switch).

**Check:** Start-stop multivibrator circuit failure will show these characteristics. Off-tolerance precision (1%) resistors in this circuit will sometimes cause this problem.

Sweep timing off at several of the slower sweep speeds (below 1 ms/div).

**Check:** Suspect precision timing resistors. Many older oscilloscopes used brown A-P resistors on the sweep timing switches. These resistors changed value with age and should all be changed.

Sweep nonlinear or inaccurate at slow sweep speeds. (In extreme cases, spot may stop part way through the sweep.)

**Check:** The disconnect diodes should be tested. Check for proper operation by starting the sweep and then remove the disconnect diode to see if the problem clears itself. The sweep will run for one sweep and stop. Replace the diode and repeat the procedure if necessary to get a better look. If this procedure clears up the problem, the disconnect diode is faulty (leaky).

Sweep nonlinear at some TIME/CM settings; normal operation at others.

**Check:** Leaky Miller runup or rundown circuit. Check for faulty transistor.

## TROUBLESHOOTING THE HORIZONTAL SECTION

Sweep inoperative.

Check: Check the sweep gate transistor and the sweep TD. If these operate properly, then check the fixed divider at the input of the sweep reset multivibrator for proper value.

Sweep inoperative.

Check: If normal troubleshooting doesn't produce a trace, check the sweep length circuit. A diode failure or bad switch contact in the sweep length circuit may cause an inoperative sweep.

Sweep timing error at different sweep speeds.

Check: Diodes used in the sweep disconnect circuit may be defective. Replace if necessary.

Sweep jitter.

Check: Diodes used in the sweep disconnect circuit may be defective. Replace if necessary.

# TROUBLESHOOTING THE HORIZONTAL SECTION

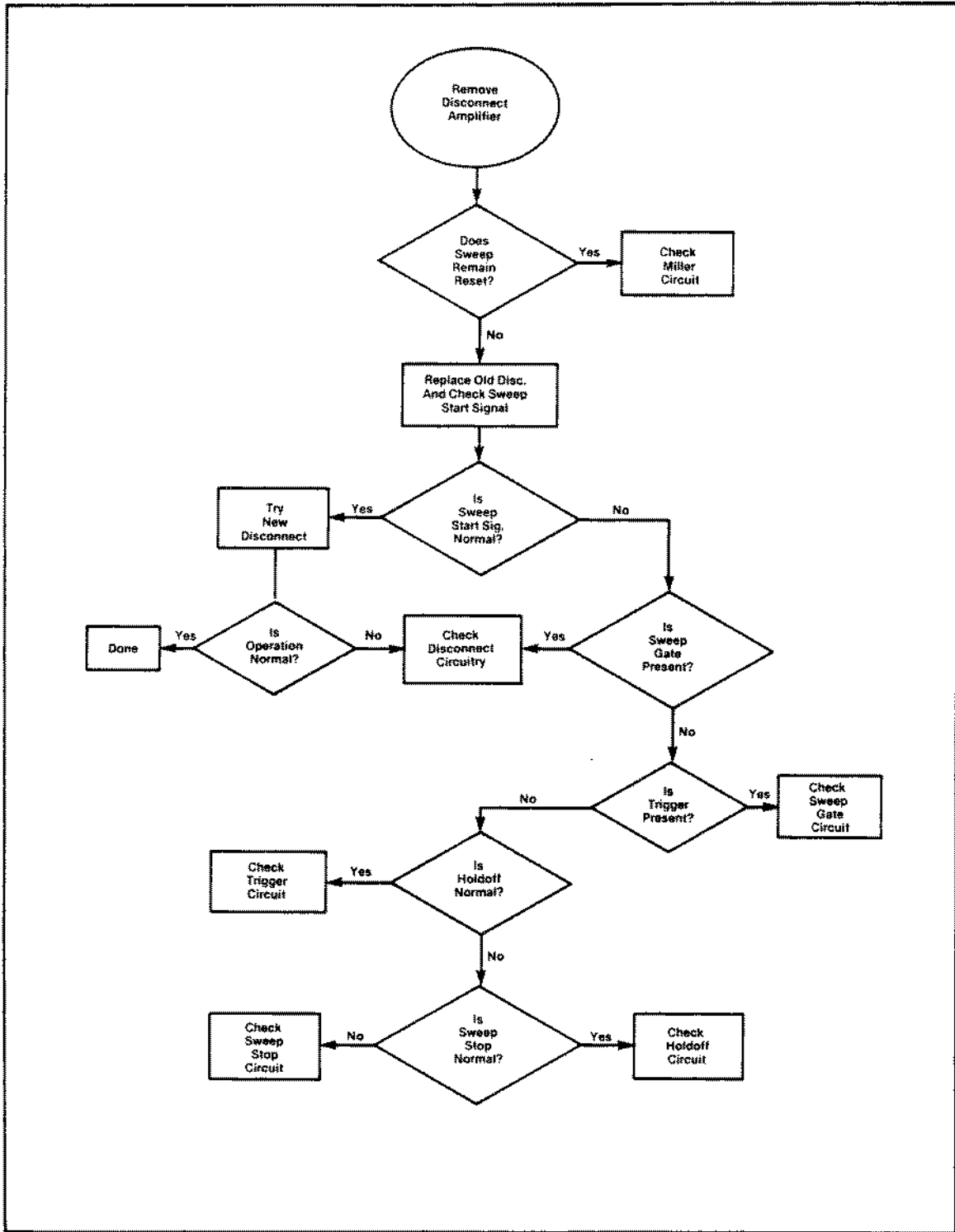

If sweep is latched in reset state, spot off screen on left side.

# TROUBLESHOOTING THE HORIZONTAL SECTION

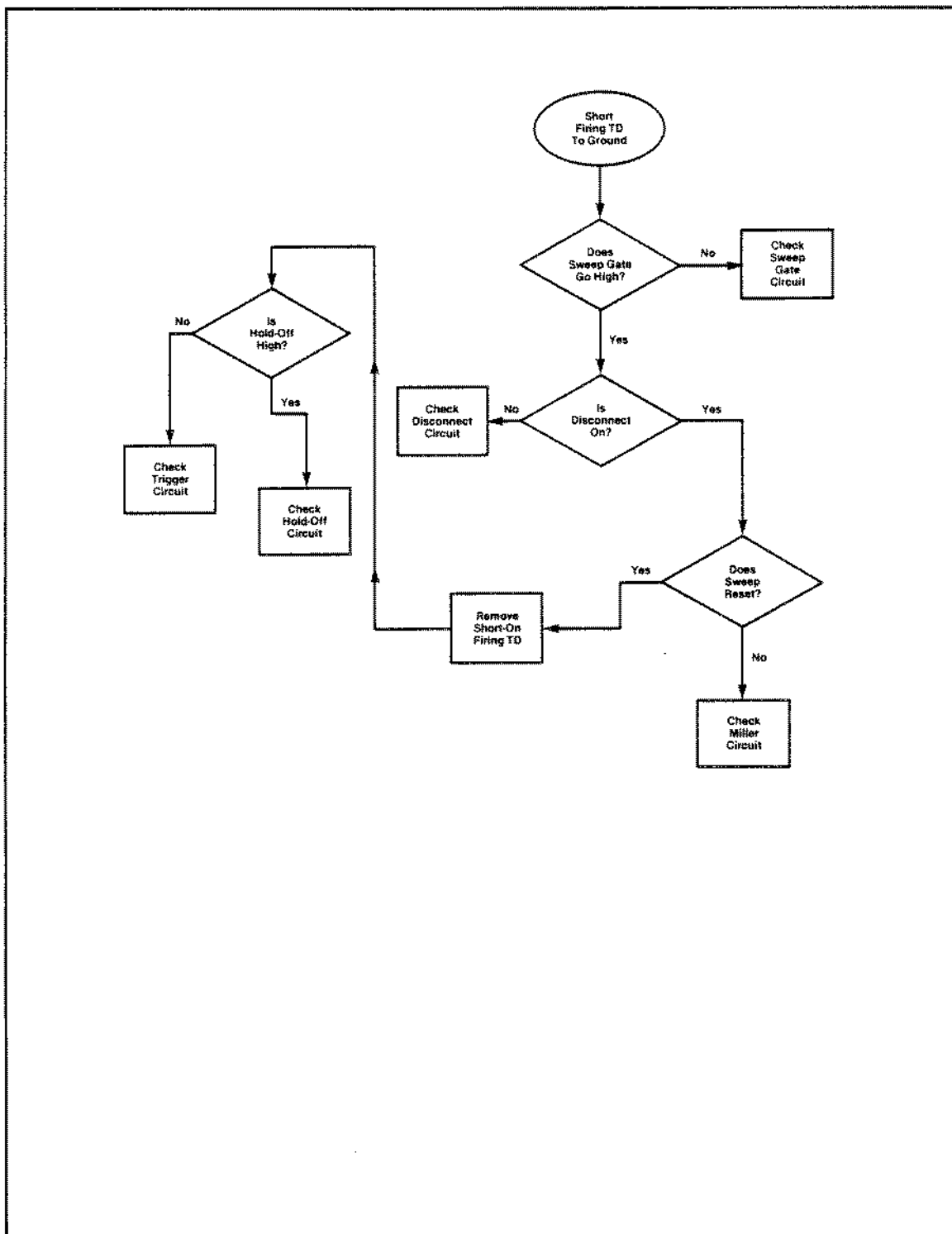

If sweep is latched in rundown state, trace off screen on right side.