

Cascadable Silicon Bipolar MMIC Amplifier

Technical Data

MSA-0304

Features

- **Cascadable 50 Ω Gain Block**
- **3 dB Bandwidth:**
DC to 1.6 GHz
- **11.0 dB Typical Gain at
1.0 GHz**
- **10.0 dBm Typical P_{1 dB} at
1.0 GHz**
- **Unconditionally Stable
(k>1)**
- **Low Cost Plastic Package**

Description

The MSA-0304 is a high performance silicon bipolar Monolithic Microwave Integrated Circuit (MMIC) housed in a low cost

plastic package. This MMIC is designed for use as a general purpose 50 Ω gain block. Typical applications include narrow and broad band IF and RF amplifiers in industrial and military applications.

The MSA-series is fabricated using HP's 10 GHz f_T , 25 GHz f_{MAX} , silicon bipolar MMIC process which uses nitride self-alignment, ion implantation, and gold metallization to achieve excellent performance, uniformity and reliability. The use of an external bias resistor for temperature and current stability also allows bias flexibility.

04A Plastic Package

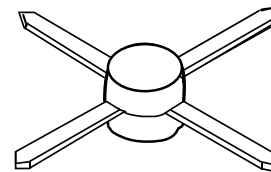

Typical Biasing Configuration

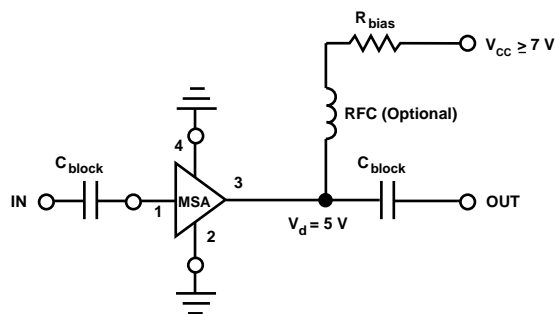

MSA-0304 Absolute Maximum Ratings

Parameter	Absolute Maximum ^[1]
Device Current	70 mA
Power Dissipation ^[2,3]	400 mW
RF Input Power	+13 dBm
Junction Temperature	150°C
Storage Temperature	-65 to 150°C

Thermal Resistance^[2,4]:

$$\theta_{jc} = 100^{\circ}\text{C}/\text{W}$$

Notes:

1. Permanent damage may occur if any of these limits are exceeded.
2. $T_{\text{CASE}} = 25^{\circ}\text{C}$.
3. Derate at 10 mW/°C for $T_{\text{C}} > 110^{\circ}\text{C}$.
4. See MEASUREMENTS section "Thermal Resistance" for more information.

Electrical Specifications^[1], $T_{\text{A}} = 25^{\circ}\text{C}$

Symbol	Parameters and Test Conditions: $I_{\text{d}} = 35 \text{ mA}$, $Z_0 = 50 \Omega$	Units	Min.	Typ.	Max.
GP	Power Gain ($ S_{21} ^2$) f = 0.1 GHz f = 0.5 GHz f = 1.0 GHz	dB	10.0	12.5 12.0 11.0	
ΔGP	Gain Flatness f = 0.1 to 1.3 GHz	dB		± 1.0	
$f_3 \text{ dB}$	3 dB Bandwidth	GHz		1.6	
VSWR	Input VSWR f = 0.1 to 3.0 GHz			1.3:1	
	Output VSWR f = 0.1 to 3.0 GHz			1.6:1	
NF	50 Ω Noise Figure f = 1.0 GHz	dB		6.0	
$P_{1 \text{ dB}}$	Output Power at 1 dB Gain Compression f = 1.0 GHz	dBm		10.0	
IP ₃	Third Order Intercept Point f = 1.0 GHz	dBm		23.0	
t_{D}	Group Delay f = 1.0 GHz	psec		150	
V_{d}	Device Voltage	V	4.5	5.0	5.5
dV/dT	Device Voltage Temperature Coefficient	mV/°C		-8.0	

Note:

1. The recommended operating current range for this device is 20 to 50 mA. Typical performance as a function of current is on the following page.

MSA-0304 Typical Scattering Parameters ($Z_0 = 50 \Omega$, $T_A = 25^\circ\text{C}$, $I_d = 35 \text{ mA}$)

Freq. GHz	S_{11}		S_{21}			S_{12}			S_{22}	
	Mag	Ang	dB	Mag	Ang	dB	Mag	Ang	Mag	Ang
0.1	.10	173	12.5	4.24	173	-18.5	.120	3	.12	-13
0.2	.10	162	12.5	4.21	167	-18.2	.123	4	.12	-24
0.4	.09	142	12.2	4.08	153	-18.0	.125	7	.13	-46
0.6	.08	127	11.9	3.93	141	-17.8	.128	10	.15	-64
0.8	.07	110	11.5	3.76	130	-17.3	.136	14	.16	-78
1.0	.06	92	11.1	3.58	118	-16.8	.144	16	.17	-91
1.5	.03	58	10.0	3.15	93	-15.5	.169	19	.19	-117
2.0	.03	175	8.8	2.76	71	-14.1	.197	18	.20	-139
2.5	.05	163	7.8	2.46	55	-13.2	.218	18	.21	-158
3.0	.12	148	6.8	2.20	38	-12.2	.246	15	.22	-174
3.5	.19	129	5.9	1.98	20	-11.2	.275	7	.24	171
4.0	.26	110	5.0	1.77	3	-10.6	.296	1	.26	158
5.0	.44	77	3.0	1.41	-28	-9.9	.319	-15	.29	128
6.0	.63	52	0.4	1.05	-56	-10.2	.310	-31	.37	94

A model for this device is available in the DEVICE MODELS section.

Typical Performance, $T_A = 25^\circ\text{C}$

(unless otherwise noted)

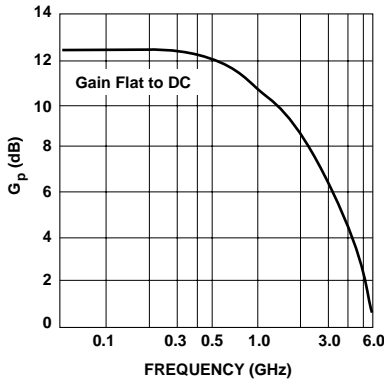

Figure 1. Typical Power Gain vs. Frequency, $T_A = 25^\circ\text{C}$, $I_d = 35 \text{ mA}$.

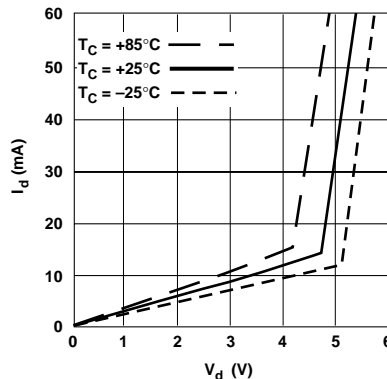

Figure 2. Device Current vs. Voltage.

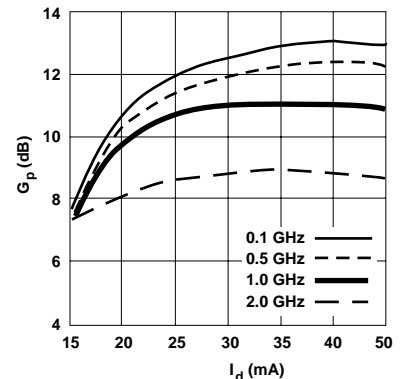

Figure 3. Power Gain vs. Current.

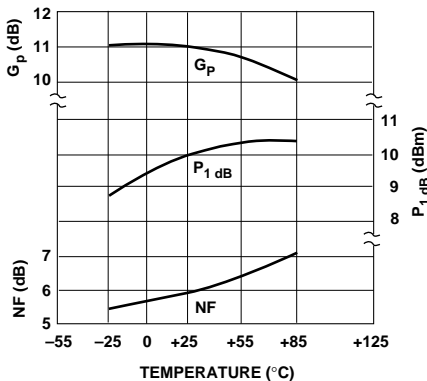

Figure 4. Output Power at 1 dB Gain Compression, NF and Power Gain vs. Case Temperature, $f = 1.0 \text{ GHz}$, $I_d = 35 \text{ mA}$.

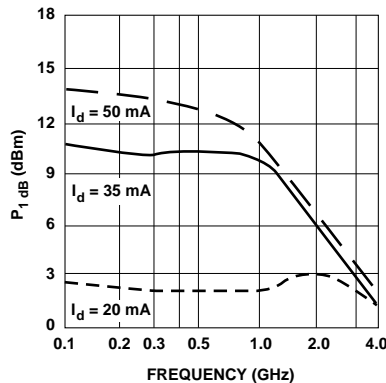

Figure 5. Output Power at 1 dB Gain Compression vs. Frequency.

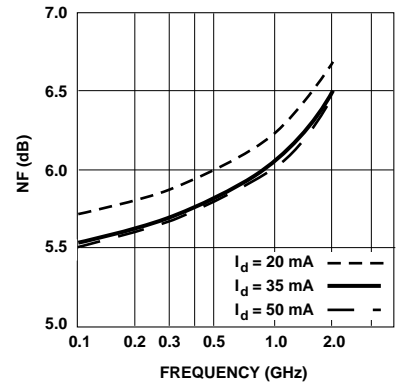

Figure 6. Noise Figure vs. Frequency.

04A Plastic Package Dimensions

